



**irritec**  
IRRIGATION SYSTEMS SINCE 1979

General price list 2011



don't wait for rain™

**Quality Management System**  
ISO 9001:2008



**Environmental Management System**  
ISO 14001:2004



**ITALY**  
Connecto Plus - PN 16



**GERMANY**  
Connecto +Ultra - PN 10



**AUSTRALIA**  
Connecto Plus - PN 16



**SOUTH AFRICA**  
Connecto Plus - PN 16



**RUSSIA**

Plastic fittings



Hygienic Certificate



Accessories



Metal filters  
Fertigation Benches



**ISRAEL**  
Connecto - PN 10



**HUNGARY**  
Connecto - PN 10  
Connecto Plus - PN 16  
Clamp saddles



**CONNECTO - PN 10  
CONNECTO PLUS - PN 16  
CLAMP SADDLES**



**POLAND**

Hygienic Certificate





Drip irrigation Microirrigation	5
Filtering	19
Fertigation Automation	33
Fittings Valves low pressure	43
Fittings Valves high pressure	63
Residential irrigation	85
Accessories	103

## Abbreviations

<b>bar</b>	bar working pressure
<b>bar outlet</b>	bar outlet pressure
<b>bolts</b>	quantity of bolts
<b>box</b>	quantity per package
<b>capacity</b>	capacity liter
<b>closing</b>	closing pressure bar
<b>closing l/h</b>	closing flow rate l/h
<b>colour</b>	identification colour
<b>connections</b>	type of connections
<b>D</b>	size in mm
<b>D manifold</b>	manifold size in mm
<b>D body</b>	body size in mm
<b>dn</b>	size flanged connections
<b>dosing</b>	measuring percentage
<b>€</b>	unit price in Euro
<b>fertilizers</b>	quantity of fertilizers managed
<b>filtering element</b>	type of filtering element
<b>filters</b>	quantity of filters used
<b>flow control</b>	flow control presence
<b>G</b>	size in inches
<b>H</b>	height mm
<b>hp</b>	power electric motor
<b>L</b>	length in mm
<b>L axis</b>	axis length mm
<b>L micropipe</b>	micropipe length mm
<b>l/h</b>	nominal flow rate l/h
<b>lower base</b>	dimensions mm lower base
<b>manifold</b>	manufacturing material of manifold
<b>max flow rate m<sup>3</sup>/h</b>	max flow rate m <sup>3</sup> /h
<b>micropipe</b>	type of micropipe
<b>model</b>	version - type - functions
<b>m<sup>3</sup>/h</b>	nominal flow rate m <sup>3</sup> /h
<b>opening</b>	opening pressure bar
<b>pack</b>	quantity per bag/pack
<b>PFA (PN)</b>	nominal pressure bar
<b>power supply</b>	type of power supply
<b>radius</b>	radius m
<b>ref.</b>	item code
<b>scale</b>	used scale
<b>stock</b>	■ normally available    ■ available on request
<b>stake</b>	type of stake
<b>suction l/h</b>	suction capacity l/h
<b>type</b>	type of package
<b>upper base</b>	dimensions mm upper base
<b>way</b>	quantity of way
<b>zone</b>	quantity of zones



	page
iDROP™ drippers	6
iDROP™ drippers accessories	7
Various drippers	8
Stakes	9
Microfittings	10
Hooks and accessories	11
Irritec® static sprinklers	12
Agridor sprinklers	13-15
Agridor accessories	16
Sprinklers medium and long radius	17





### ON LINE PRESSURE COMPENSATING DRIPPER

- Uniform flow rate from 6 to 50 m.w.h. The correct item for systems with long laterals and big slopes.
- Suitable for orchards, vineyards, greenhouses, nurseries and wherever a precise flow rate is required.
- Turbulent flow to avoid sedimentation and clogging.
- Made of last generation polymers to last long and to be resistant to commonly used chemical agents and fertilizers.
- The colour of the base identifies the flow rate.
- Working pressure range from 6 to 50 m.w.h.
- Outlet suitable for connections to micropipe (4 mm I.D.) and multi-way manifold (1, 2, 4 and multiple).
- Available with Drop-Stop system (no-leakage):
  - Opening pressure: 4 m.w.h.
  - Sealing pressure: 3 m.w.h.
- Assembly on PE pipe (3 mm hole with item FUS page 104)



DCG



pressure compensating  
iDROP™ dripper



Ref.	l/h	colour	€	pack	box	type	stock
IMDCG2000A020	2 l/h	blue	0,122	500	3000	C	<input type="checkbox"/>
IMDCG2000M030	3 l/h	brown	0,122	500	3000	C	<input type="checkbox"/>
IMDCG2000V040	4 l/h	green	0,122	500	3000	C	<input type="checkbox"/>
IMDCG2000G060	6 l/h	grey	0,122	500	3000	C	<input type="checkbox"/>
IMDCG2000R080	8 l/h	red	0,122	500	3000	C	<input type="checkbox"/>

DCS



Pressure compensating no leakage (cni)  
iDROP™ dripper



Ref.	l/h	colour	€	pack	box	type	stock
IMDCS2H00A020	2 l/h	blue	0,122	500	3000	C	<input type="checkbox"/>
IMDCS2H00M030	3 l/h	brown	0,122	500	3000	C	<input type="checkbox"/>
IMDCS2H00V040	4 l/h	green	0,122	500	3000	C	<input type="checkbox"/>
IMDCS2H00G060	6 l/h	grey	0,122	500	3000	C	<input type="checkbox"/>
IMDCS2H00R080	8 l/h	red	0,122	500	3000	C	<input type="checkbox"/>



### DRIPPERS WITH TURBULENT FLOW

- Suitable for orchards, vineyards, greenhouses, nurseries and wherever a precise flow rate is required.
- Turbulent flow to avoid sedimentation and clogging.
- Made of last generation polymers to last long and to be resistant to commonly used chemical agents and fertilizers.
- The colour of the base identifies the flow rate.
- Outlet suitable for connections to micropipe (4 mm I.D.) and multi-way manifold (1, 2, 4 and multiple).
- Due to the less clogging possibilities, the iDROP drippers are not inspectable and do not need any maintenance.
- Assembly on PE pipe (3 mm hole with item FUS page 104)



DNG



on line iDROP™ dripper



Ref.	l/h	colour	€	pack	box	type	stock
IMDNG2000A020	2 l/h	blue	0,067	500	3000	C	<input type="checkbox"/>
IMDNG2000V040	4 l/h	green	0,067	500	3000	C	<input type="checkbox"/>
IMDNG2000R080	8 l/h	red	0,067	500	3000	C	<input type="checkbox"/>

M01



1 way manifold for iDROP™



Ref.	D	€	pack	box	type	stock
IMMO12000N030	3 mm	<b>0,023</b>	500	20000	C	<input type="checkbox"/>

M02



2 way manifold for iDROP™



Ref.	D	€	pack	box	type	stock
IMMO22000N030	3 mm	<b>0,055</b>	500	14000	C	<input type="checkbox"/>

M04



4 way manifold for iDROP™



Ref.	D	€	pack	box	type	stock
IMMO42000N030	3 mm	<b>0,055</b>	500	10000	C	<input type="checkbox"/>

MV4



4 way manifold for iDROP™



Ref.	D	€	pack	box	type	stock
IMMV42000N030	3 mm	<b>0,055</b>	500	7000	C	<input type="checkbox"/>

MC2



2 way capillary manifold for iDROP™



Ref.	D	€	pack	box	type	stock
IMMC22000A032	3,2 mm	<b>0,099</b>	500	3000	C	<input type="checkbox"/>

MC4



4 way capillary manifold for iDROP™



Ref.	D	€	pack	box	type	stock
IMMC42000V032	3,2 mm	<b>0,099</b>	500	3000	C	<input type="checkbox"/>

KH1



1 way iDROP™ assembly



Ref.	L. micropipe	stake	€	box	type	stock
IMKH1SD200040	40 cm	ASD	<b>0,202</b>	100	B	<input type="checkbox"/>
IMKH1ID200040	40 cm	AID (15 cm)	<b>0,228</b>	100	B	<input type="checkbox"/>
IMKH1SD200050	50 cm	ASD	<b>0,217</b>	100	B	<input type="checkbox"/>
IMKH1ID200050	50 cm	AID (15 cm)	<b>0,243</b>	100	B	<input type="checkbox"/>
IMKH1SD200060	60 cm	ASD	<b>0,233</b>	100	B	<input type="checkbox"/>
IMKH1ID200060	60 cm	AID (15 cm)	<b>0,258</b>	100	B	<input type="checkbox"/>
IMKH1SD200080	80 cm	ASD	<b>0,263</b>	100	B	<input type="checkbox"/>
IMKH1ID200080	80 cm	AID (15 cm)	<b>0,263</b>	100	B	<input type="checkbox"/>

KH2



2 way iDROP™ assembly



Ref.	L. micropipe	stake	€	box	type	stock
IMKH2SD200040	40 cm	ASD	<b>0,415</b>	100	B	<input type="checkbox"/>
IMKH2ID200040	40 cm	AID (15 cm)	<b>0,465</b>	100	B	<input type="checkbox"/>
IMKH2SD200050	50 cm	ASD	<b>0,446</b>	100	B	<input type="checkbox"/>
IMKH2ID200050	50 cm	AID (15 cm)	<b>0,495</b>	100	B	<input type="checkbox"/>
IMKH2SD200060	60 cm	ASD	<b>0,475</b>	100	B	<input type="checkbox"/>
IMKH2ID200060	60 cm	AID (15 cm)	<b>0,526</b>	100	B	<input type="checkbox"/>
IMKH2SD200080	80 cm	ASD	<b>0,536</b>	100	B	<input type="checkbox"/>
IMKH2ID200080	80 cm	AID (15 cm)	<b>0,585</b>	100	B	<input type="checkbox"/>

KH4



4 way iDROP™ assembly



Ref.	L. micropipe	stake	€	box	type	stock
IMKH4SD200040	40 cm	ASD	<b>0,746</b>	100	B	<input type="checkbox"/>
IMKH4ID200040	40 cm	AID (15 cm)	<b>0,845</b>	100	B	<input type="checkbox"/>
IMKH4SD200050	50 cm	ASD	<b>0,806</b>	100	B	<input type="checkbox"/>
IMKH4ID200050	50 cm	AID (15 cm)	<b>0,905</b>	100	B	<input type="checkbox"/>
IMKH4SD200060	60 cm	ASD	<b>0,866</b>	100	B	<input type="checkbox"/>
IMKH4ID200060	60 cm	AID (15 cm)	<b>0,966</b>	100	B	<input type="checkbox"/>
IMKH4SD200080	80 cm	ASD	<b>0,986</b>	100	B	<input type="checkbox"/>
IMKH4ID200080	80 cm	AID (15 cm)	<b>1,090</b>	100	B	<input type="checkbox"/>

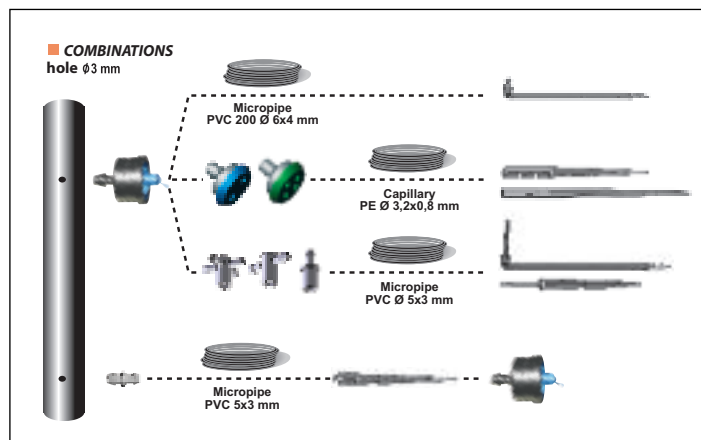

## DSV



inspectable dripper with filter  
vertical outlet



Ref.	l/h	€	pack	box	type	stock
IMDSV2000N004	4	0,148	-	1200	B	<input type="checkbox"/>
IMDSV2000N008	8	0,148	-	1200	B	<input type="checkbox"/>
IMDSV2000N016	16	0,148	-	1200	B	<input type="checkbox"/>

## DSH



inspectable dripper with filter  
rear outlet



Ref.	l/h	€	pack	box	type	stock
IMDSH2000N004	4	0,148	-	1200	B	<input type="checkbox"/>
IMDSH2000N008	8	0,148	-	1200	B	<input type="checkbox"/>
IMDSH2000N016	16	0,148	-	1200	B	<input type="checkbox"/>

## DIS



inspectable dripper with hook



Ref.	l/h	€	pack	box	type	stock
IMDIS2000N040	4	0,137	-	1200	B	<input type="checkbox"/>
IMDIS2000N080	8	0,137	-	1200	B	<input type="checkbox"/>
IMDIS2000N150	15	0,137	-	1200	B	<input type="checkbox"/>

## DMS



mini inspectable dripper with hook



Ref.	l/h	€	pack	box	type	stock
IMDMS2000N040	4	0,109	250	1750	B	<input type="checkbox"/>
IMDMS2000N080	8	0,109	250	1750	B	<input type="checkbox"/>
IMDMS2000N100	10	0,109	250	1750	B	<input type="checkbox"/>
IMDMS2000N150	15	0,109	250	1750	B	<input type="checkbox"/>

## DIA



pressure compensating inspectable dripper



Ref.	l/h	€	pack	box	type	stock
IMDIA2000N040	4	0,127	500	5000	B	<input type="checkbox"/>
IMDIA2000N080	8	0,127	500	5000	B	<input type="checkbox"/>

## DIN



normal drum dripper



Ref.	l/h	€	pack	box	type	stock
IZDIN2000N040	4	0,077	500	4000	B	<input type="checkbox"/>
IZDIN2000N080	8	0,077	500	4000	B	<input type="checkbox"/>

## SNA



stake with adjustable dripper



Ref.	l/h	€	pack	box	type	stock
IMSNA2000ND0F	0 - 40	0,125	25	1500	C	<input type="checkbox"/>

## DNA



adjustable dripper



Ref.	l/h	€	pack	box	type	stock
IMDNA2000ND0F	0 - 40	0,059	100	5000	C	<input type="checkbox"/>

For PE pipe assembly make a 3 mm hole with item FUS (page 104)



**ASD** | dripper stake



1,7 l/h  
2,6 l/h

**irritec**

Ref.	l/h	€	pack	box	type	stock
IMASD2000N017	1,7	<b>0,032</b>	250	4000	B	<input checked="" type="checkbox"/>
IMASD2000N026	2,6	<b>0,029</b>	250	4000	B	<input checked="" type="checkbox"/>

**AID** | 100° dripper stake



**irritec**

Ref.	l/h	H	€	pack	box	type	stock
IMAID2010N026	2,6	100	<b>0,049</b>	250	3000	B	<input checked="" type="checkbox"/>
IMAID2015N026	2,6	150	<b>0,057</b>	-	900	C	<input checked="" type="checkbox"/>

**AIM** | 45° stake for micropipe 3-4 mm



**irritec**

Ref.	-	€	pack	box	type	stock
IMAIM2000N030	-	<b>0,046</b>	250	2000	B	<input checked="" type="checkbox"/>

**AIP** | 100° stake for micropipe 3-4 mm



**irritec**

Ref.	H	€	pack	box	type	stock
IMAIP2010N030	100	<b>0,037</b>	250	4000	B	<input checked="" type="checkbox"/>
IMAIP2015N030	150	<b>0,042</b>	250	2000	B	<input checked="" type="checkbox"/>

**ASS** | spring stake for micropipe 3-4 mm



**irritec**

Ref.	l/h	€	pack	box	type	stock
IMASS2000N025	25	<b>0,029</b>	500	6000	B	<input checked="" type="checkbox"/>

**ASG** | stake for micropipe 5-6 mm



**irritec**

Ref.	-	€	pack	box	type	stock
IMASG2000N000	-	<b>0,027</b>	500	6000	B	<input checked="" type="checkbox"/>

**ASC** | stake for capillaries 2 holes



**irritec**

Ref.	-	€	pack	box	type	stock
IMASC2000N000	-	<b>0,029</b>	250	2500	B	<input checked="" type="checkbox"/>

**AIC** | 45° stake for capillaries 2,5 - 3,2 mm



**irritec**

Ref.	-	€	pack	box	type	stock
IMAIC2000N000	-	<b>0,045</b>	250	2500	B	<input checked="" type="checkbox"/>

**AST** | stake for capillaries 2,5 - 3,2 mm self-threading



**irritec**

Ref.	colour	€	pack	box	type	stock
IMAST2000A000	blue	<b>0,031</b>	800	3200	C	<input checked="" type="checkbox"/>
IMAST2000N000	black	<b>0,030</b>	800	3200	C	<input checked="" type="checkbox"/>
IMAST2000R000	red	<b>0,031</b>	800	3200	C	<input checked="" type="checkbox"/>

minicoupling for PE/PEM micropipe



Ref.	D	micropipe	€	pack	box	type	stock
IM7146000N037	3.75	PE 3 x 5	0,022	500	12000	C	<input type="checkbox"/>
IM7146000N040	4	PEM 3 x 5	0,022	500	12000	C	<input type="checkbox"/>
IM7146000N052	5.25	PE 4 x 6	0,022	500	10000	C	<input type="checkbox"/>
IM7146000N055	5.5	PEM 4 x 6	0,022	500	10000	C	<input type="checkbox"/>
IM7146000N070	7	PE 6 x 8	0,024	500	10000	C	<input type="checkbox"/>
IM7146000N080	8	PE/PEM 7 x 10	0,024	500	8000	C	<input type="checkbox"/>

minicoupling for PVC micropipe semi-flexible (200-S) / flexible (201-F)



Ref.	D	micropipe	€	pack	box	type	stock
IM7156000N050	5	S. / F. 3 x 5,5	0,022	500	12000	C	<input type="checkbox"/>
IM7156000N055	5.5	S. 4 x 6	0,022	500	10000	C	<input type="checkbox"/>
IM7156000N065	6.5	F. 4 x 6	0,022	500	10000	C	<input type="checkbox"/>
IM7156000N070	7	S. 5 x 8	0,022	500	10000	C	<input type="checkbox"/>
IM7156000N080	8	F. 5 x 8	0,024	500	8000	C	<input type="checkbox"/>
IM7156000N090	9	S. 7 x 10	0,024	500	8000	C	<input type="checkbox"/>

threaded adaptor



Ref.	D	micropipe	€	pack	box	type	stock
IM7086000N040	4	3 x 5,5 + 4 x 6	0,053	500	25000	C	<input type="checkbox"/>

threaded /insert adaptor



Ref.	D	micropipe	€	pack	box	type	stock
IM7096000N035	3,5	3 x 5,5 + 4 x 6	0,049	500	25000	C	<input type="checkbox"/>

tee for micropipe



Ref.	D	micropipe	€	pack	box	type	stock
IM7032000N035	3,5	3 x 5,5 + 4 x 6	0,073	500	12000	C	<input type="checkbox"/>
IM7032000N070	7	5 x 8	0,094	500	7000	C	<input type="checkbox"/>

tee offtake for micropipe



Ref.	D	micropipe	€	pack	box	type	stock
IM7072000N035	3,5	3 x 5,5 + 4 x 6	0,058	500	12000	C	<input type="checkbox"/>
IM7072000N070	7	5 x 8	0,073	500	6000	C	<input type="checkbox"/>

plug



Ref.	D	-	€	pack	box	type	stock
IM7002000N040	4	-	0,014	500	15000	C	<input type="checkbox"/>
IM7002000N060	6	-	0,018	500	15000	C	<input type="checkbox"/>
IM7002000N080	8	-	0,024	500	10000	C	<input type="checkbox"/>
IM7002000N100	10	-	0,026	500	10000	C	<input type="checkbox"/>

elbow for micropipe



Ref.	D	micropipe	€	pack	box	type	stock
IM7022000N035	3,5	3 x 5,5 + 4 x 6	0,069	500	20000	C	<input type="checkbox"/>
IM7022000N070	7	5 x 8	0,090	500	10000	C	<input type="checkbox"/>

4 way minicoupling for micropipe 3 mm



Ref.	D	micropipe	€	pack	box	type	stock
IM7132000N030	3	3 x 5,5 + 4 x 6	0,253	500	3000	C	<input type="checkbox"/>

Micropipes,  
look them up in Siplast™  
"Microirrigation 2011" price list





end clamp



Ref.	D	€	pack	box	type	stock
IIFL2000N160	16	<b>0,032</b>	200	2400	B	<input type="checkbox"/>
IIFL2000N200	20	<b>0,041</b>	200	1600	B	<input type="checkbox"/>



support hook



Ref.	D	€	pack	box	type	stock
IIGAN2000N160	16	<b>0,022</b>	500	6000	B	<input type="checkbox"/>
IIGAN2000N200	20	<b>0,028</b>	200	4000	B	<input type="checkbox"/>



water stop hook



Ref.	D	€	pack	box	type	stock
IIGRG2000N160	16	<b>0,025</b>	500	6000	B	<input type="checkbox"/>
IIGRG2000N200	20	<b>0,031</b>	200	4000	B	<input type="checkbox"/>
IIGRG2000N250	25	<b>0,077</b>	200	2000	B	<input type="checkbox"/>
IIGRG2000N320	32	<b>0,092</b>	100	1000	B	<input type="checkbox"/>



long water stop hook



Ref.	D	€	pack	box	type	stock
IIGRL2000N160	16	<b>0,091</b>	-	1500	B	<input type="checkbox"/>
IIGRL2000N200	20	<b>0,095</b>	-	1200	B	<input type="checkbox"/>



spike for dripline



Ref.	D	€	pack	box	stock
IIPDL2000N160	16	<b>0,084</b>	-	400	<input type="checkbox"/>
IIPDL2000N200	20	<b>0,089</b>	-	400	<input type="checkbox"/>

## MSU

threaded body for microjet



Ref.	D	colour	€	pack	box	type	stock
IMMSU6000I010	1.0 mm	ivory	0,029	500	22000	C	<input type="checkbox"/>
IMMSU6000V012	1.2 mm	green	0,029	500	22000	C	<input type="checkbox"/>
IMMSU6000R015	1.5 mm	red	0,029	500	22000	C	<input type="checkbox"/>
IMMSU6000A020	2.0 mm	blue	0,029	500	22000	C	<input type="checkbox"/>
IMMSU6000N022	2.2 mm	black	0,029	500	22000	C	<input type="checkbox"/>

## MFG

threaded body for microjet



Ref.	D	colour	€	pack	box	type	stock
IMMFG6000Y008	0,8 mm	yellow	0,029	500	22000	C	<input type="checkbox"/>
IMMFG6000I010	1,0 mm	ivory	0,029	500	22000	C	<input type="checkbox"/>
IMMFG6000V013	1,3 mm	green	0,029	500	22000	C	<input type="checkbox"/>
IMMFG6000R015	1,5 mm	red	0,029	500	22000	C	<input type="checkbox"/>
IMMFG6000M018	1,8 mm	brown	0,029	500	22000	C	<input type="checkbox"/>
IMMFG6000U020	2,0 mm	blue	0,029	500	22000	C	<input type="checkbox"/>
IMMFG6000N023	2,3 mm	black	0,029	500	22000	C	<input type="checkbox"/>
IMMFG6000G025	2,5 mm	grey	0,029	500	22000	C	<input type="checkbox"/>

## 706

threaded /insert butterfly sprinkler



Ref.	D	€	pack	box	type	stock
IM7062000N010	1.0 mm	0,125	500	1500	B	<input type="checkbox"/>
IM7062000N015	1.5 mm	0,125	500	1500	B	<input type="checkbox"/>
IM7062000N020	2.0 mm	0,125	500	1500	B	<input type="checkbox"/>
IM7062000N025	2.5 mm	0,125	500	1500	B	<input type="checkbox"/>
IM7062000N030	3.0 mm	0,125	500	1500	B	<input type="checkbox"/>
IM7062000N035	3.5 mm	0,125	500	1500	B	<input type="checkbox"/>
IM7062000N040	4.0 mm	0,125	500	1500	B	<input type="checkbox"/>

### Characteristics MSU - MFG - 706 at 1,5 bar

D	MSU		MFG		706	
	l/h	radius	l/h	radius	l/h	radius
0,8 mm	-	-	26	1,9	-	-
1,0 mm	39	1,9	44	2,1	60	1,5
1,2 mm	55	2,4	-	-	-	-
1,3 mm	-	-	71	2,8	-	-
1,5 mm	85	2,6	97	3,2	100	1,8
1,8 mm	-	-	134	3,4	-	-
2,0 mm	122	2,8	157	3,6	150	2,0
2,2 mm	130	2,9	-	-	-	-
2,3 mm	-	-	198	3,8	-	-
2,5 mm	-	-	210	3,9	200	2,2
3,0 mm	-	-	-	-	250	2,5
3,5 mm	-	-	-	-	300	2,8
4,0 mm	-	-	-	-	350	3,0

## MST

head for microjet MSU



Ref.	model	€	pack	box	type	stock
IMMST6000N180	180°	0,032	500	30000	C	<input type="checkbox"/>
IMMST6000N360	360°	0,032	500	30000	C	<input type="checkbox"/>

## TGN

head for microjet MFG



Ref.	model	€	pack	box	type	stock
IMTGN6000N180	180°	0,029	500	22000	C	<input type="checkbox"/>
IMTGN6000N360	360°	0,029	500	22000	C	<input type="checkbox"/>

## TGA

anti insect head for microjet MFG



Ref.	model	€	pack	box	type	stock
IMTGA6000N180	180°	0,057	500	12000	C	<input type="checkbox"/>
IMTGA6000N360	360°	0,057	500	12000	C	<input type="checkbox"/>

## TCP

stabilizer LDPE pipe 9 x 12



Ref.	H	€	pack	box	type	stock
FMB12090P030	300	0,108	100	-	-	<input type="checkbox"/>
FMB12090P050	500	0,150	100	-	-	<input type="checkbox"/>
FMB12090P100	1000	0,299	100	-	-	<input type="checkbox"/>

## TBR

PP rigid micropipe 7 x 4 mm



Ref.	H	€	pack	box	type	stock
FMP07040P030	300	0,150	100	-	-	<input type="checkbox"/>
FMP07040P050	500	0,241	100	-	-	<input type="checkbox"/>
FMP07040P100	1000	0,464	100	-	-	<input type="checkbox"/>

920



double jet mini dynamic sprinkler  
irrigated area 14 - 16 m diameter

EIN DOR AGRIDOR

Ref.	D	l/h*	radius*	€	pack	box	stock
ID920180	1,9 mm	180	7	2,19	100	-	
ID920200	2,0 mm	200	7	2,19	100	-	
ID920240	2,2 mm	240	7,5	2,19	100	-	
ID920300	2,4 mm	300	8	2,19	100	-	
ID920400	2,8 mm	400	8	2,19	100	-	
ID920450	3,0 mm	450	8	2,19	100	-	

940



double jet mini dynamic sprinkler 1/2" thread,  
irrigated area 14 - 16 m diameter

EIN DOR AGRIDOR

Ref.	D	l/h*	radius*	€	pack	box	stock
ID940180	1,9 mm	180	7	3,47	100	-	
ID940200	2,0 mm	200	7,2	3,47	100	-	
ID940240	2,2 mm	240	7,5	3,47	100	-	
ID940300	2,4 mm	300	8	3,47	100	-	

961



single jet mini sprinkler  
irrigated area 12,0 - 12,5 m diameter

EIN DOR AGRIDOR

Ref.	D	l/h*	radius*	€	pack	box	stock
ID961120	1,5 mm	120	6	1,74	100	-	
ID961160	1,8 mm	160	6,2	1,74	100	-	

961P



single jet part circle mini sprinkler  
irrigated area 12 diameter

Ref.	D	l/h*	radius*	€	pack	box	stock
ID961120P	1,5 mm	120	6	2,83	100	-	

861



"minicompact" mini sprinkler  
irrigated area 5,6 ÷ 9,0 m diameter

EIN DOR AGRIDOR

Ref.	D	l/h*	radius*	€	pack	box	stock
ID861035	0,8 mm	35	2,7	0,498	100	-	
ID861040	0,9 mm	40	2,7	0,498	100	-	
ID861050	1,0 mm	50	3,1	0,498	100	-	
ID861060	1,1 mm	60	3,5	0,498	100	-	
ID861070	1,2 mm	70	3,5	0,498	100	-	
ID861090	1,3 mm	90	3,5	0,498	100	-	
ID861105	1,4 mm	105	3,7	0,498	100	-	
ID861120	1,5 mm	120	4	0,498	100	-	
ID861140	1,7 mm	140	4,2	0,498	100	-	
ID861160	1,8 mm	160	4,5	0,498	100	-	

862



"minicompact" mini sprinkler  
irrigated area 3,8 ÷ 7,2 m diameter

Ref.	D	l/h*	radius*	€	pack	box	stock
ID862035	0,8 mm	35	1,9	0,498	100	-	
ID862040	0,9 mm	40	2,3	0,498	100	-	
ID862050	1,0 mm	50	2,7	0,498	100	-	
ID862060	1,1 mm	60	2,8	0,498	100	-	
ID862070	1,2 mm	70	3	0,498	100	-	
ID862090	1,3 mm	90	3,2	0,498	100	-	
ID862105	1,4 mm	105	3,2	0,498	100	-	
ID862120	1,5 mm	120	3,2	0,498	100	-	
ID862140	1,7 mm	140	3,5	0,498	100	-	
ID862160	1,8 mm	160	3,6	0,498	100	-	

863



"minicompact" mini sprinkler  
irrigated area 3,8 m diameter

EIN DOR AGRIDOR

Ref.	D	l/h*	radius*	€	pack	box	stock
ID863020	0,9 (NFR)	20	1,9	0,498	100	-	

866



"minicompact" mini sprinkler  
for upside down irrigation  
irrigated area 6,6 ÷ 8,6 m diameter

Ref.	D	l/h*	radius*	€	pack	box	stock
ID866035	0,8 mm	35	3,3	0,498	100	-	
ID866040	0,9 mm	40	3,3	0,498	100	-	
ID866050	1,0 mm	50	3,3	0,498	100	-	
ID866060	1,1 mm	60	4	0,498	100	-	
ID866070	1,2 mm	70	4	0,498	100	-	
ID866090	1,3 mm	90	4	0,498	100	-	
ID866105	1,4 mm	105	4	0,498	100	-	
ID866120	1,5 mm	120	4	0,498	100	-	
ID866140	1,7 mm	140	4	0,498	100	-	
ID866160	1,8 mm	160	4,3	0,498	100	-	

\* The indicated characteristics are calculated at 2 bar working pressure

831



bridge mini sprinkler  
irrigated area 5,7 ÷ 10,4 m diameter

EIN DOR AGRIDOR

Ref.	D	l/h*	radius*	€	pack	box	stock
ID831035	0,8 mm	35	2,8	0,443	100	-	
ID831040	0,9 mm	40	3	0,443	100	-	
ID831050	1,0 mm	50	3,4	0,443	100	-	
ID831060	1,1 mm	60	3,5	0,443	100	-	
ID831070	1,2 mm	70	4	0,443	100	-	
ID831090	1,3 mm	90	4	0,443	100	-	
ID831105	1,4 mm	105	4,2	0,443	100	-	
ID831120	1,5 mm	120	4,4	0,443	100	-	
ID831140	1,7 mm	140	4,9	0,443	100	-	
ID831160	1,8 mm	160	5	0,443	100	-	
ID831200	2,0 mm	200	5,1	0,443	100	-	
ID831240	2,2 mm	240	5,2	0,443	100	-	

801



bridge mini sprinkler  
irrigated area 5,3 ÷ 10,5 m diameter

EIN DOR AGRIDOR

Ref.	D	l/h*	radius*	€	pack	box	stock
ID801020	0,6 mm	20	2,7	0,453	100	-	
ID801035	0,8 mm	35	2,8	0,453	100	-	
ID801040	0,9 mm	40	3	0,453	100	-	
ID801050	1,0 mm	50	3,1	0,453	100	-	
ID801060	1,1 mm	60	3,4	0,453	100	-	
ID801070	1,2 mm	70	3,8	0,453	100	-	
ID801090	1,3 mm	90	3,9	0,453	100	-	
ID801105	1,4 mm	105	4	0,453	100	-	
ID801120	1,5 mm	120	4	0,453	100	-	
ID801140	1,7 mm	140	4,4	0,453	100	-	
ID801160	1,8 mm	160	4,5	0,453	100	-	
ID801200	2,0 mm	200	5	0,453	100	-	
ID801240	2,2 mm	240	5,2	0,453	100	-	

803



bridge mini sprinkler for upside down irrigation  
irrigated area 6,9 ÷ 10,2 m diameter

EIN DOR AGRIDOR

Ref.	D	l/h*	radius*	€	pack	box	stock
ID803035	0,8 mm	35	3,4	0,461	100	-	
ID803040	0,9 mm	40	3,5	0,461	100	-	
ID803050	1,0 mm	50	3,6	0,461	100	-	
ID803060	1,1 mm	60	3,8	0,461	100	-	
ID803070	1,2 mm	70	3,9	0,461	100	-	
ID803090	1,3 mm	90	4,1	0,461	100	-	
ID803105	1,4 mm	105	4,3	0,461	100	-	
ID803120	1,5 mm	120	4,4	0,461	100	-	
ID803140	1,7 mm	140	4,6	0,461	100	-	
ID803160	1,8 mm	160	4,8	0,461	100	-	
ID803200	2,0 mm	200	5	0,461	100	-	
ID803240	2,2 mm	240	5,1	0,461	100	-	

850



part circle bridge mini sprinkler

EIN DOR AGRIDOR

Ref.	D	l/h*	radius*	€	pack	box	stock
ID850050	1,0 mm	50	3	0,560	100	-	
ID850070	1,2 mm	70	3,5	0,560	100	-	
ID850090	1,3 mm	90	3,5	0,560	100	-	

4460



360° static sprayer irrigated  
area 3,2 ÷ 4,0 m diameter

EIN DOR AGRIDOR

Ref.	D	l/h*	radius*	€	pack	box	stock
ID4460040	1,3 mm	40	1,6	0,272	100	-	
ID4460060	1,3 mm	60	2	0,272	100	-	
ID4460070	1,8 mm	70	1,9	0,272	100	-	
ID4460090	2,0 mm	90	2	0,272	100	-	

4461



320° static sprayer irrigated  
area 3,2 ÷ 4,0 m diameter

EIN DOR AGRIDOR

Ref.	D	l/h*	radius*	€	pack	box	stock
ID4461040	1,3 mm	40	1,6	0,272	100	-	
ID4461060	1,3 mm	60	2	0,272	100	-	
ID4461070	1,8 mm	70	1,9	0,272	100	-	
ID4461090	2,0 mm	90	2	0,272	100	-	

4462



360° static sprayer irrigated  
area 2,4 ÷ 3,3 m diameter

EIN DOR AGRIDOR

Ref.	D	l/h*	radius*	€	pack	box	stock
ID4462020	1,0 mm	20	1,2	0,272	100	-	
ID4462040	1,3 mm	40	1,7	0,272	100	-	
ID4462060	1,3 mm	60	1,8	0,272	100	-	
ID4462070	1,8 mm	70	1,6	0,272	100	-	
ID4462090	2,0 mm	90	1,7	0,272	100	-	

4463



360° static sprayer irrigated  
area 0,7 ÷ 0,9 m diameter

EIN DOR AGRIDOR

Ref.	D	l/h*	radius*	€	pack	box	stock
ID4463020	1,0 mm	20	0,4	0,272	100	-	
ID4463040	1,3 mm	40	0,5	0,272	100	-	
ID4463060	1,3 mm	60	0,5	0,272	100	-	
ID4463070	1,8 mm	70	0,5	0,272	100	-	
ID4463090	2,0 mm	90	0,5	0,272	100	-	

\* The indicated characteristics are calculated at 2 bar working pressure

4452



180° static sprayer irrigated  
area 1,8 ÷ 2,4 m diameter

EIN DOR AGRIDOR

Ref.	D	l/h*	radius*	€	pack	box	stock
ID4452040	1,3 mm	40	1,8	0,272	100	3000	
ID4452060	1,3 mm	60	2	0,272	100	3000	
ID4452070	1,8 mm	70	2	0,272	100	3000	
ID4452090	2,0 mm	90	2,4	0,272	100	3000	

4454



90° static sprayer irrigated  
area 2,2 ÷ 2,9 m diameter

EIN DOR AGRIDOR

Ref.	D	l/h*	radius*	€	pack	box	stock
ID4454040	1,3 mm	40	2,2	0,272	100	3000	
ID4454060	1,3 mm	60	2,9	0,272	100	3000	

4442



twin ellipse static sprayer

EIN DOR AGRIDOR

Ref.	D	l/h*	area*	€	pack	box	stock
ID4442020	1,0 mm	20	0,5x0,8	0,272	100	-	
ID4442040	1,3 mm	40	0,6x0,9	0,272	100	-	
ID4442070	1,8 mm	70	0,8x1,2	0,272	100	-	
ID4442090	2,0 mm	90	1,0x1,8	0,272	100	-	

4444



ellipse static sprayer

EIN DOR AGRIDOR

Ref.	D	l/h*	area*	€	pack	box	stock
ID4444040	1,3 mm	40	3,8x1,5	0,272	100	-	
ID4444060	1,3 mm	60	5,6x1,8	0,272	100	-	
ID4444070	1,8 mm	70	4,0x2,8	0,272	100	-	
ID4444090	2,0 mm	90	5,0x2,8	0,272	100	-	

4191



320° mister static sprayer irrigated  
area 2,2 ÷ 3,2 m diameter

EIN DOR AGRIDOR

Ref.	D	l/h*	radius*	€	pack	box	stock
ID4191012	0,5 mm	12	1,1	0,301	100	-	
ID4191020	0,6 mm	20	1,1	0,301	100	-	
ID4191035	0,8 mm	35	1,2	0,301	100	-	
ID4191050	1,0 mm	50	1,4	0,301	100	-	
ID4191070	1,2 mm	70	1,5	0,301	100	-	
ID4191090	1,3 mm	90	1,6	0,301	100	-	

700



360° dynamic sprayer irrigated  
area 3,0 ÷ 5,4 m diameter

EIN DOR AGRIDOR

Ref.	D	l/h*	radius*	€	pack	box	stock
ID700040		40	1,5	0,239	100	-	
ID700060		60	2	0,239	100	-	
ID700070		70	2,2	0,239	100	-	
ID700090		90	2,3	0,239	100	-	
ID700105		105	2,5	0,239	100	-	
ID700120		120	2,6	0,239	100	-	
ID700160		160	2,7	0,239	100	-	

530



non-drip valve

EIN DOR AGRIDOR

Ref.	opening	closing	€	pack	box	stock
ID53005 (L)	1,0 ± 0,2	0,4 ± 0,1	0,763	100	-	
ID53010 (H)	1,5 ± 0,2	0,7 ± 0,1	0,763	100	-	

500



pressure regulator

EIN DOR AGRIDOR

Ref.	bar	l/h	€	pack	box	stock
ID500014	1,4	35-160	1,02	100	-	
ID500020	2,0	35-160	1,02	100	-	
ID500020H	2,0	160-300	1,02	100	-	

\* The indicated characteristics are calculated at 2 bar working pressure

EIN DOR AGRIDOR ①

Ref.	fig.	€	pack	box	stock
ID10351	1	0,054	100	-	■
ID10364	2	0,054	100	-	■
ID10319	3	0,044	100	-	■
ID10335	4	0,054	100	-	■
ID12096	5	0,109	100	-	■
ID10348	6	0,063	100	-	■
ID10377	7	0,063	100	-	■
ID10306	8	0,063	100	-	■
ID10393	9	0,073	100	-	■
ID920080M (5 x 8 mm)	10	0,220	100	-	■
ID920080M13 (9 x 13 mm)	10	0,263	100	-	■
ID10555	11	0,283	100	-	■
ID10500	12	0,150	100	-	■
ID10827	13	0,241	100	-	■
ID10814	14	0,241	100	-	■
ID10400	15	0,069	100	-	■
ID10487	16	0,094	100	-	■
ID10429	17	0,098	100	-	■
ID10474	18	0,090	100	-	■
ID10380	19	0,042	100	-	■
ID10445	20	0,057	100	-	■
ID10461	21	0,057	100	-	■
ID10115 (25 cm.)	22	0,315	100	-	■
ID10157 (35 cm.)	22	0,336	100	-	■
IDAML0410 (4 mm x 100 cm)	23	*	100	-	■
IDAML0615 (6 mm x 150 cm)	23	1,00	100	-	■
IDAML0812 (8 mm x 120 cm)	23	2,30	100	-	■
ID13015	24	4,19	100	-	■
ID13060	25	7,05	100	-	■
ID13206	26	3,79	100	-	■

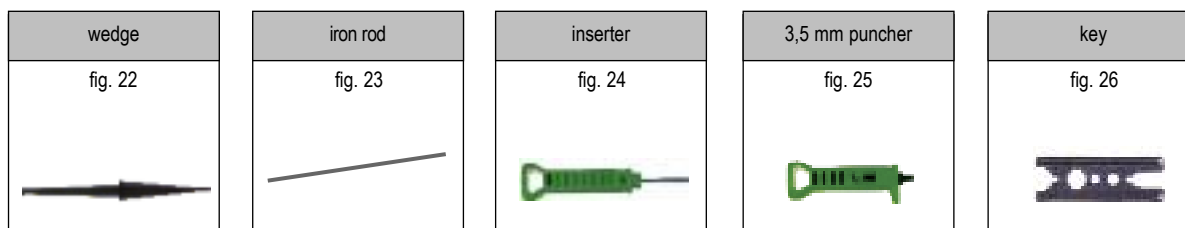
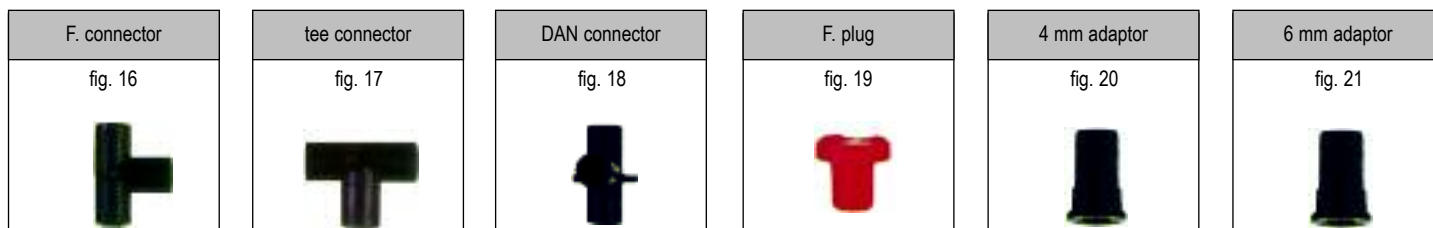
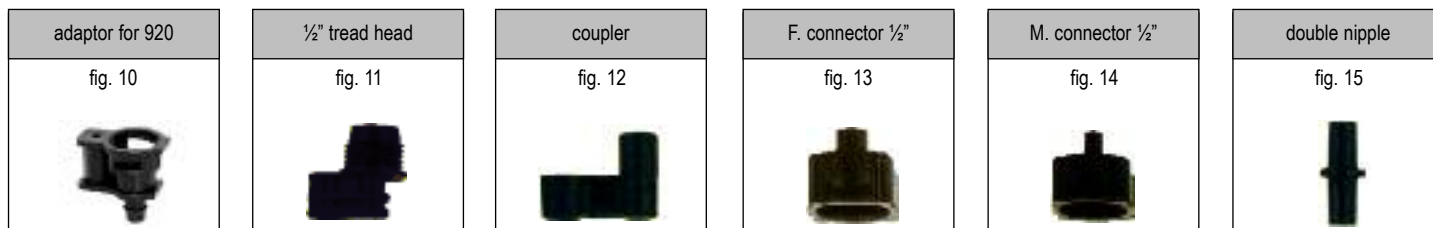
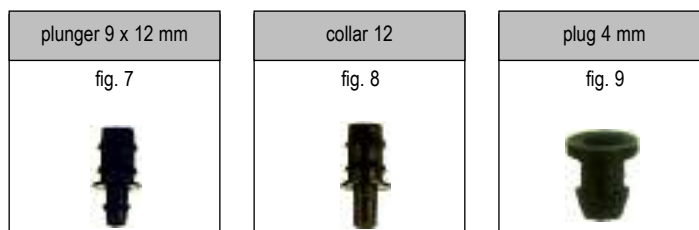
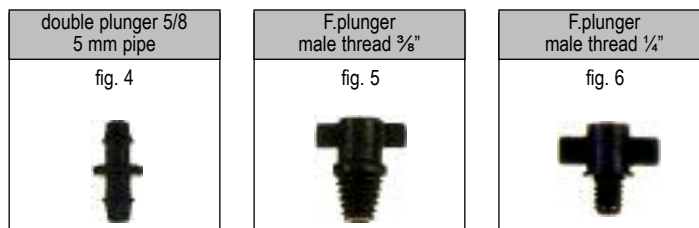
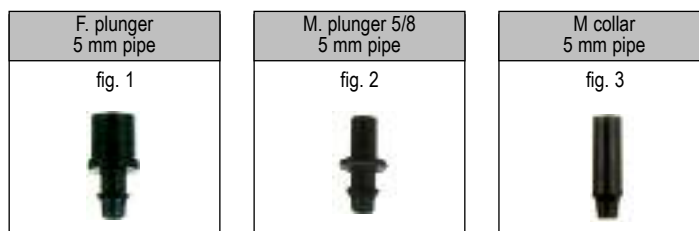

\* on request



IRC 22



plastic full circle impact sprinkler 1/2" M



Ref.	D	l/h	radius	€	pack	box	stock
IMIRC22B2518	2,5 x 1,8	528	10	4,20	50	150	
IMIRC22B3018	3 x 1,8	762	10,5	4,20	50	150	
IMIRC22B3525	3,5 x 2,5	1.062	11,5	4,20	50	150	

STD



complete assembly mod. 52 with Pvc pipe  
13x9 H 1200 + connections,  
suitable for 8 mm rod (not included)



Ref.	-	€	pack	box	stock
IMSTD52	-	1,95	1	100	

R10T



mini dynamic sprinkler R10 Turbo  
diameter 11,6 ÷ 18,8 m.



Ref.	D	l/h	€	pack	box	stock
IWR10TP61570B	P6/15 - 70	172	4,20	1	-	
IWR10TP61578B	P6/15 - 78	217	4,20	1	-	
IWR10TP61507B	P6/15 - 0,7 FC	170	4,20	1	-	
IWR10TP82494B	P8/24 - 94	311	4,20	1	-	
IWR10TP824102B	P8/24 - 102	366	4,20	1	-	
IWR10TP82412B	P8/24 - 1,25 FC	284	4,20	1	-	

KIT



complete assembly mod. FT with Pvc pipe  
13x9 H 1200 + connections,  
suitable for 8 mm rod (not included)



Ref.	-	€	pack	box	type	stock
IWKITFT12120	-	1,12	-	-	-	

F30



metal full circle impact sprinkler 3/4" M



Ref.	G	l/h	radius	€	pack	box	stock
IMF30CMID	11/64"+3/32"	1.492	13,7	13,80	1	42	

F40



metal full circle impact sprinkler 3/4" M



Ref.	G	l/h	radius	€	pack	box	stock
IMF40CMLDV	3/16"+3/32"	528	14,9	17,20	1	36	
IMF40CMNFV	7/32"+1/8"	762	15,7	17,20	1	36	

F44



plastic full circle impact sprinkler 3/4" M



Ref.	G	l/h	radius	€	pack	box	stock
IMF44CMNFV	7/32"+1/8"	2.521	15,8	7,60	1	65	

F46



plastic full circle impact sprinkler 3/4" M



Ref.	G	l/h	radius	€	pack	box	stock
IMF46CMIDV	11/64"+3/32"	1.494	14,7	5,60	1	78	

P45



plastic part circle impact sprinkler 3/4" M



Ref.	G	l/h	radius	€	pack	box	stock
IMP45CMNTV	7/32"	1.830	16,7 m	9,40	1	40	





	page
Manual plastic filters	<b>20-25</b>
Automatic plastic filters	<b>26-27</b>
Coated metal filters	<b>28-30</b>
Filter accessories	<b>31-32</b>



## Y FILTERS

Irritec® filters allow the best filtering protection for any irrigation system. Their simple and safe frame, result of an accurate construction technology, minimise the need for maintenance. These filters can withstand pressure changes and external stress, and their main feature is the strong and flexible filtering element. Tightness is ensured also at high pressures, and the filtering elements deliver optimum filtering efficiency. The wide range of filtering grades (20 to 450 mesh) can meet all filtering requirements.

### Characteristics

Polypropylene filter

Filtering element: disk, stainless steel and polyester screen.

Maximum working pressure: 10 bar at 20°C

Available connections: threaded BSP, NPT

Discharge: inspectable plug (excluded FLC)

closing systems

S.S. clamp



nylon nut



threaded cap



Table 1 - available mesh (x = available)

models YCV - YDV - YEV - YFV						
colour	mesh	micron	ref.	s.s.	polyester	disk
	20	800	E	x	x	-
	30	500	F	x	x	-
	50	300	G	x	x	-
	75	200	H	x	x	-
	100	160	I	x	x	-
	120	130	L	x	x	x
	155	100	N	x	x	-
	200	80	P	x	x	-
	450	22	R	x	x	-

Table 2 - available mesh (x = available)

models YGG - YHG - YGF - YHF						
colour	mesh	micron	ref.	s.s.	polyester	disk
	75	200	H	x	x	x
	120	130	L	x	x	x
	155	100	N	x	x	x

YCV (FLC)



on line filter 120 mesh\*  
model "C"

irritec

Ref.	G	m³/h	cartridge	€	box	type	stock
• IFYCVCILM2S0N	¾"	5	s.s.	2,98	30	C	
• IFYCVCPMLM2S0N	¾"	5	polyester	3,50	30	C	
• IFYCVDILM2S0N	1"	5	s.s.	2,98	30	C	
• IFYCVDPLM2S0N	1"	5	polyester	3,50	30	C	

YDV (FLD)



on line filter 120 mesh\*  
model "D"

irritec

Ref.	G	m³/h	cartridge	€	box	type	stock
• IFYDVCILM2C0N	¾"	5	s.s.	4,00	20	C	
• IFYDVCPLM2C0N	¾"	5	polyester	4,40	20	C	
• IFYDVCPLM2C0N	¾"	5	disk	4,94	20	C	
• IFYDVIDLM2C0N	1"	5	s.s.	4,00	20	C	
• IFYDVIDLM2C0N	1"	5	polyester	4,40	20	C	
• IFYDVIDLM2C0N	1"	5	disk	4,94	20	C	

YEV (FLE)



on line filter 120 mesh\*  
model "E"

irritec

Ref.	G	m³/h	cartridge	€	box	type	stock
• IFYVEILM2C0N	1" ¼"	10	s.s.	5,60	10	C	
• IFYVEPLM2C0N	1" ¼"	10	polyester	6,07	10	C	
• IFYVEDLM2C0N	1" ¼"	10	disk	8,25	10	C	
• IFYVEFILM2C0N	1" ½"	10	s.s.	5,70	10	C	
• IFYVEFPLM2C0N	1" ½"	10	polyester	6,16	10	C	
• IFYVEFDLM2C0N	1" ½"	10	disk	8,42	10	C	

YFV (FLF)



on line filter 120 mesh\*  
model "F"

irritec

Ref.	G	m³/h	cartridge	€	box	type	stock
• IFYFVILM2C0N	1" ½"	20	s.s.	9,00	10	B	
• IFYFVPLM2C0N	1" ½"	20	polyester	10,10	10	B	
• IFYFVDLM2C0N	1" ½"	20	disk	16,20	10	B	
• IFYFVGILM2C0N	2"	20	s.s.	9,40	10	B	
• IFYFVGILM2C0N	2"	20	polyester	10,40	10	B	
• IFYFVGILM2C0N	2"	20	disk	16,50	10	B	

\* = for other mesh see table 1

• NPT thread available

YGG (FGG)



on line filter 120 mesh\*  
model "G" with nut



Ref.	G	m³/h	cartridge	€	box	type	stock
• IFYGGGPLM2C0N	2"	25	polyester	<b>68,30</b>	2	B	<input type="checkbox"/>
• IFYGGGILM2C0N	2"	25	s.s.	<b>68,30</b>	2	B	<input type="checkbox"/>
• IFYGGDDL2C0N	2"	25	disk	<b>72,60</b>	2	B	<input type="checkbox"/>

YGF (FLG)



on line filter 120 mesh\*  
model "G" with s.s. clamp



Ref.	G	m³/h	cartridge	€	box	type	stock
• IFYGFGPLM2C0N	2"	25	polyester	<b>104,70</b>	2	B	<input type="checkbox"/>
• IFYGFILM2C0N	2"	25	s.s.	<b>104,70</b>	2	B	<input type="checkbox"/>
• IFYGFDDL2C0N	2"	25	disk	<b>109,00</b>	2	B	<input type="checkbox"/>

YHG (FGH)



on line filter 120 mesh\*  
model "H" with nut



Ref.	G	m³/h	cartridge	€	box	type	stock
• IFYHGGPLM2C0N	2" super	25	polyester	<b>74,50</b>	4	F	<input type="checkbox"/>
• IFYHGGILM2C0N	2" super	25	s.s.	<b>74,50</b>	4	F	<input type="checkbox"/>
• IFYHGGDLM2C0N	2" super	25	disk	<b>81,00</b>	4	F	<input type="checkbox"/>
• IFYHGIPLM2C0N	3"	50	polyester	<b>78,60</b>	4	F	<input type="checkbox"/>
• IFYHGIILM2C0N	3"	50	s.s.	<b>78,60</b>	4	F	<input type="checkbox"/>
• IFYHGIDL2C0N	3"	50	disk	<b>84,30</b>	4	F	<input type="checkbox"/>

YHF (FLH)



on line filter 120 mesh\*  
model "H" with s.s. clamp



Ref.	G	m³/h	cartridge	€	box	type	stock
• IFYHFGPLM2C0N	2" super	25	polyester	<b>111,80</b>	4	F	<input type="checkbox"/>
• IFYHFGILM2C0N	2" super	25	s.s.	<b>111,80</b>	4	F	<input type="checkbox"/>
• IFYHFGDLM2C0N	2" super	25	disk	<b>118,00</b>	4	F	<input type="checkbox"/>
• IFYHFIPLM2C0N	3"	50	polyester	<b>118,70</b>	4	F	<input type="checkbox"/>
• IFYHFILM2C0N	3"	50	s.s.	<b>118,70</b>	4	F	<input type="checkbox"/>
• IFYHFIDL2C0N	3"	50	disk	<b>125,60</b>	4	F	<input type="checkbox"/>

\* = for other mesh see table 2

spare parts

description	fig.	type C		type D		type E		type F	
		Ref.	€	Ref.	€	Ref.	€	Ref.	€
Polyester cartridge 120 m.	1	IIFMC20000P12	<b>2,31</b>	IIFMD20000P12	<b>2,44</b>	IIFME20000P12	<b>3,31</b>	IIFMF20000P12	<b>4,78</b>
S.S. cartridge 120 mesh	1	IIFMC20000I12	<b>2,31</b>	IIFMD20000I12	<b>2,44</b>	IIFME20000I12	<b>3,31</b>	IIFMF20000I12	<b>4,78</b>
Disk cartridge 120 mesh	1	-	-	IIFMD20000D12	<b>3,39</b>	IIFME20000D12	<b>6,16</b>	IIFMF20000D12	<b>10,10</b>
Body	2	OIFLC20M***00	<b>1,46</b>	OIFLD20M***00	<b>1,68</b>	OIFLE20M***00	<b>2,57</b>	OIFLF20M***00	<b>6,20</b>
Cap	3	OIFCC2S000000	<b>0,70</b>	OIFCD2FM0N250	<b>1,01</b>	OIFCE2FM0N250	<b>1,31</b>	OIFCF2FM0N250	<b>3,86</b>
Or cap	4	OIGCC00000000	<b>0,46</b>	OIGCD00000000	<b>0,43</b>	OIGCE00000000	<b>0,58</b>	OIGCF00000000	<b>0,96</b>

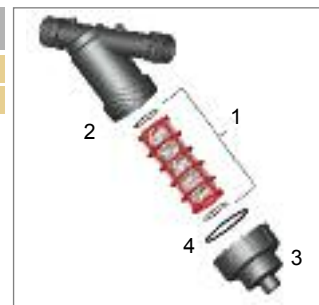

spare parts

description	fig.	type G		type H	
		Ref.	€	Ref.	€
Body for clamp closing	1A	OIFLG50M***00	<b>16,80</b>	OIFLH50M***00	<b>16,80</b>
Body for nut closing	1B	OIFGG50M***00	<b>16,80</b>	OIFGH50M***00	<b>16,80</b>
S.S. clamp	2	OFFTY00000000	<b>50,50</b>	OFFTY00000000	<b>50,50</b>
Complete S.S. cartridge 120 mesh	3	IIFMG20000I12	<b>44,50</b>	IIFMH20000I12	<b>42,00</b>
Complete disk cartridge 120 mesh	4	IIFMG5000DG12	<b>40,20</b>	IIFMH5000DI12	<b>47,60</b>
Complete polyester cartridge 120 m.	5A	IIFMG00000P12	<b>40,20</b>	IIFMH00000P12	<b>42,00</b>
Polyester sock 120 mesh	5B	OIFRG00000P12	<b>11,40</b>	OIFRH00000P12	<b>11,40</b>
Or cap	6	OIGCG00000000	<b>1,89</b>	OIGCH00000000	<b>1,89</b>
Cap for clamp closing	7A	OIFCG5F000000	<b>22,50</b>	OIFCH5F000000	<b>22,50</b>
Cap for nut closing (complete)	7B	KIFCG5F175180	<b>29,00</b>	KIFCH5F179185	<b>29,00</b>

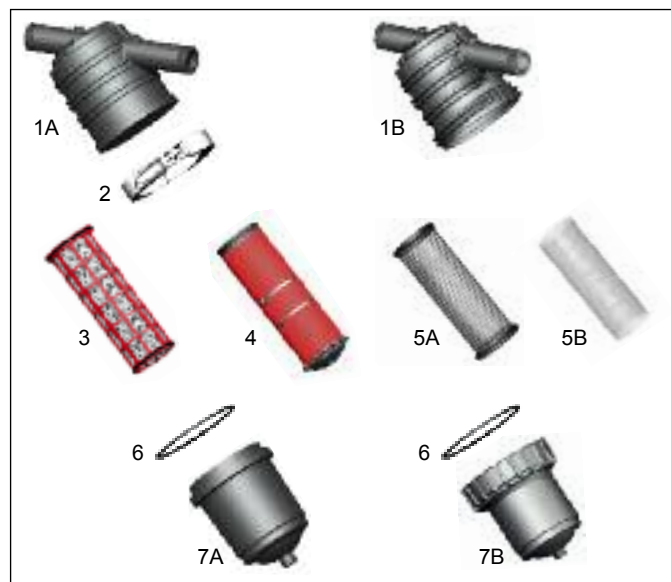

• NPT thread available

## ROTO Filters™

Manufactured with reinforced polyamide, Irritec® T filters and Rotofilters™ are suitable for both inline and angle installation. The two different closing systems, the different combinations and dimensions of the filtering elements and the available filtering grades allow you to choose always the most suitable system for every filtering need.

### Characteristics

- Filter in reinforced nylon with fiber glass
- Closing system with stainless steel clamp or nylon nut.
- Filtering element: disk, stainless steel screen.
- Filtering grade: 75, 120, 155 mesh
- Maximum working pressure: 10 bar at 20°C
- Flow rate: 2" 30 m<sup>3</sup> / h  
3" 50 m<sup>3</sup> / h
- Available connections: threaded BSP, NPT, victaulic,  
Discharge: 3/4" F. preset

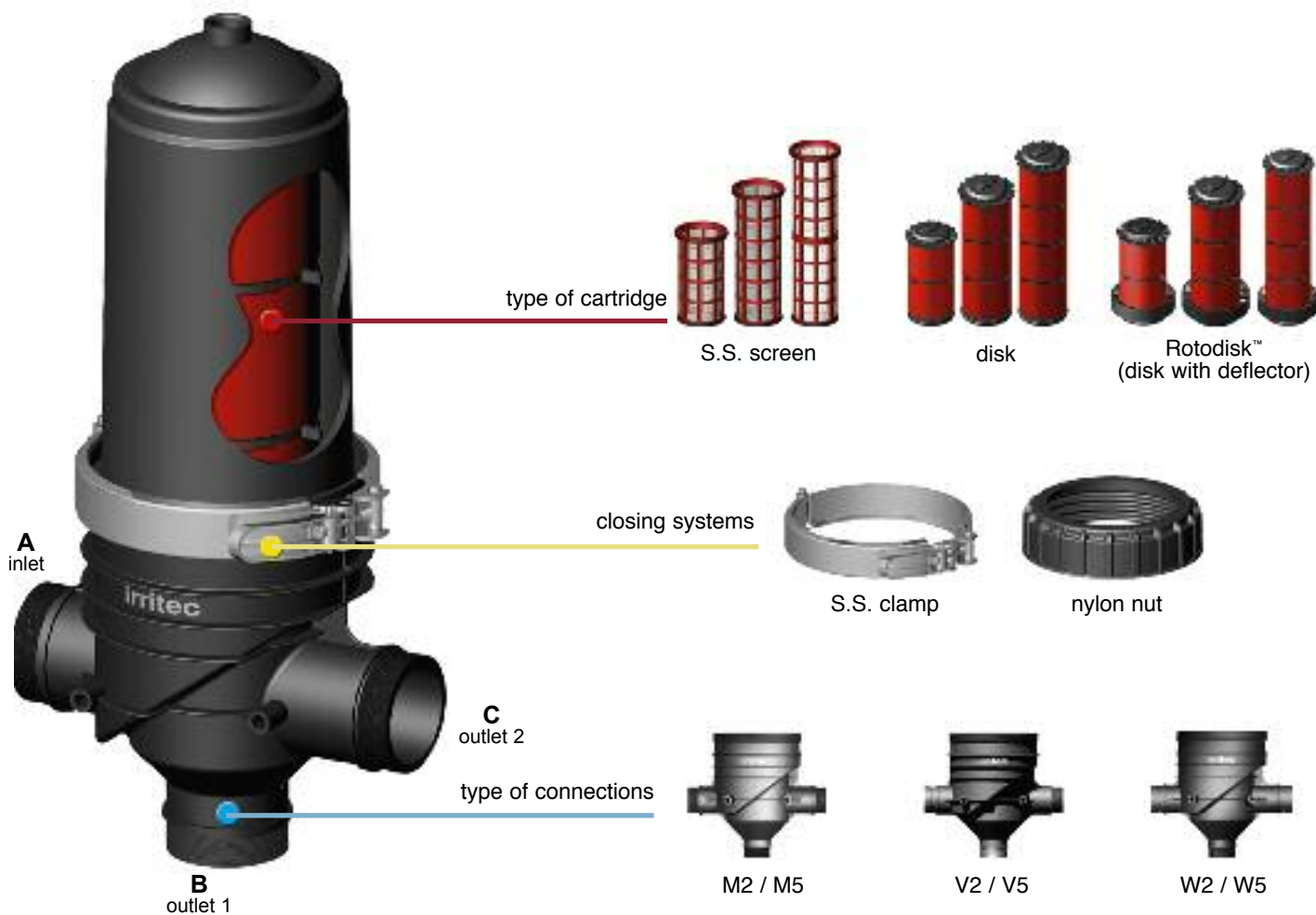
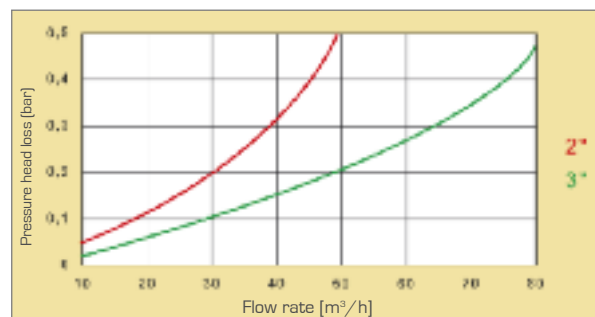

table 1 - type of mesh

Ref.	mesh	micron	colour
H	75	200	
L	120	130	
N	155	100	

Table 2 - type of connections

Ref.	A inlet	B outlet 1	C outlet 2
M2	BSP	BSP	BSP
V2	VIC	VIC	BSP
W2	VIC	BSP	VIC
M5	NPT	NPT	NPT
V5	VIC	VIC	NPT
W5	VIC	NPT	VIC



TGF



T filter 120 mesh\*  
model "G" with S.S.clamp



Ref.	G	m³/h	cartridge	€	box	type	stock
IFTGFGILxxFON	2"	30	S.S. Screen	<b>118,80</b>	1	U	<input type="checkbox"/>
IFTGFGDLxxFON	2"	30	disk	<b>121,00</b>	1	U	<input type="checkbox"/>
IFTGFGELxxFON	2"	30	Rotodisk™	<b>128,10</b>	1	U	<input type="checkbox"/>

TGG



T filter 120 mesh\*  
model "G" with nut



Ref.	G	m³/h	cartridge	€	box	type	stock
IFTGGGILxxFON	2"	30	S.S. Screen	<b>97,80</b>	1	U	<input type="checkbox"/>
IFTGGGDLxxFON	2"	30	disk	<b>100,00</b>	1	U	<input type="checkbox"/>
IFTGGGELxxFON	2"	30	Rotodisk™	<b>107,10</b>	1	U	<input type="checkbox"/>

THF



T filter 120 mesh\*  
model "H" with S.S. clamp



Ref.	G	m³/h	cartridge	€	box	type	stock
IFTHFGILxxFON	2" Super	30	S.S. Screen	<b>140,90</b>	1	T	<input type="checkbox"/>
IFTHFGDLxxFON	2" Super	30	disk	<b>143,00</b>	1	T	<input type="checkbox"/>
IFTHFGELxxFON	2" Super	30	Rotodisk™	<b>151,50</b>	1	T	<input type="checkbox"/>
IFTHFIILxxFON	3"	50	S.S. Screen	<b>157,60</b>	1	T	<input type="checkbox"/>
IFTHFIDLxxFON	3"	50	disk	<b>159,70</b>	1	T	<input type="checkbox"/>
IFTHFIELxxFON	3"	50	Rotodisk™	<b>169,20</b>	1	T	<input type="checkbox"/>

THG



T filter 120 mesh\*  
model "H" with nut



Ref.	G	m³/h	cartridge	€	box	type	stock
IFTHGGILxxFON	2" Super	30	S.S. Screen	<b>119,90</b>	1	T	<input type="checkbox"/>
IFTHGGDLxxFON	2" Super	30	disk	<b>122,00</b>	1	T	<input type="checkbox"/>
IFTHGGELxxFON	2" Super	30	Rotodisk™	<b>130,50</b>	1	T	<input type="checkbox"/>
IFTHGIILxxFON	3"	50	S.S. Screen	<b>136,60</b>	1	T	<input type="checkbox"/>
IFTHGIDLxxFON	3"	50	disk	<b>138,70</b>	1	T	<input type="checkbox"/>
IFTHGIELxxFON	3"	50	Rotodisk™	<b>148,20</b>	1	T	<input type="checkbox"/>

TIF



T filter 120 mesh\*  
model "I" with S.S. clamp



Ref.	G	m³/h	cartridge	€	box	type	stock
IFTIFIILxxFON	3"	50	S.S. Screen	<b>185,90</b>	1	T	<input type="checkbox"/>
IFTIFIDLxxFON	3"	50	disk	<b>188,50</b>	1	T	<input type="checkbox"/>
IFTIFIELxxFON	3"	50	Rotodisk™	<b>198,00</b>	1	T	<input type="checkbox"/>

TIG



T filter 120 mesh\*  
model "I" with nut



Ref.	G	m³/h	cartridge	€	box	type	stock
IFTIGIILxxFON	3"	50	S.S. Screen	<b>164,90</b>	1	T	<input type="checkbox"/>
IFTIGIDLxxFON	3"	50	disk	<b>167,50</b>	1	T	<input type="checkbox"/>
IFTIGIELxxFON	3"	50	Rotodisk™	<b>177,00</b>	1	T	<input type="checkbox"/>

\* = for other mesh see table 1

xx = specify type of connections (see tab. 2)

spare parts

description	fig.	type G		type H		type I	
		Ref.	€	Ref.	€	Ref.	€
Cap for clamp closing	1A	0IFCHN*000000	<b>23,10</b>	0IFCLN*000000	<b>34,60</b>	0IFCNN*000000	<b>47,20</b>
Cap for nut closing	1B	KIFCHNT179185	<b>37,80</b>	KIFCLNF179185	<b>56,70</b>	KIFCNNF179185	<b>66,10</b>
Or cap	2	0IGCG00000000	<b>1,89</b>	0IGCG00000000	<b>1,89</b>	0IGCG00000000	<b>1,89</b>
S.S. clamp	3	0FFTY00000000	<b>50,50</b>	0FFTY00000000	<b>50,50</b>	0FFTY00000000	<b>50,50</b>
Complete S.S. cartridge 120 mesh	4	IIFMG20000112	<b>34,50</b>	IIFMH20000112	<b>42,00</b>	IIFMI20000112	<b>71,40</b>
Complete disk cartridge 120 mesh	5	IIFMG5000DG12	<b>40,20</b>	IITMH5000DI12	<b>68,20</b>	IITMI5000DI15	<b>94,50</b>
Complete Rotodisk™ cartridge 120 m.	6	IIFMG5E00DG15	<b>63,00</b>	IITMH5E00DI12	<b>89,20</b>	IITMI5E00DI15	<b>115,50</b>
Body for clamp closing	7A	0FT0**00M*00N	<b>32,00</b>	0FT0**00M*00N	<b>32,00</b>	0FT0**00M*00N	<b>32,00</b>
Body for nut closing	7B	0FT0**00M*00N	<b>32,00</b>	0FT0**00M*00N	<b>32,00</b>	0FT0**00M*00N	<b>32,00</b>

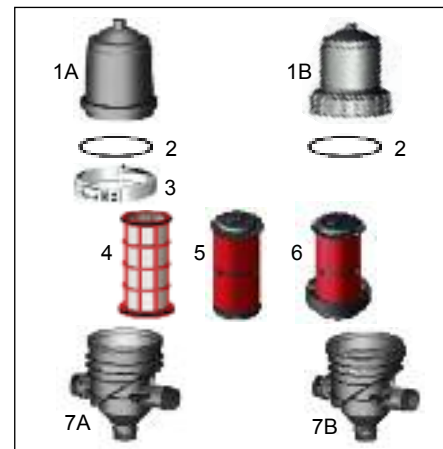

**ROTO Filters™**  
**Twin**

The new Irritec® filters Twin Rotofilters™ are manufactured with reinforced polyamide with fiber glass and are characterized by a high filtering surface. The closing system with s.s. clamp ensures a perfect seal keeping practicality during maintenance. The different models and dimensions of the filtering element and the available filtering grades allow you to choose always the most suitable system for every filtering need.

**Characteristics**

Filter in reinforced nylon with fiber glass closing system with stainless steel clamp.

Filtering element: disk, stainless steel screen.

Filtering grade: 75, 120, 155 mesh

Maximum working pressure: 10 bar at 20°C

Flow rate: 3" - dn 80 50 m³ / h

4" - dn 100 100 m³ / h

Available connections: threaded BSP, NPT, victaulic, flanged

Discharge: ¾" F. preset

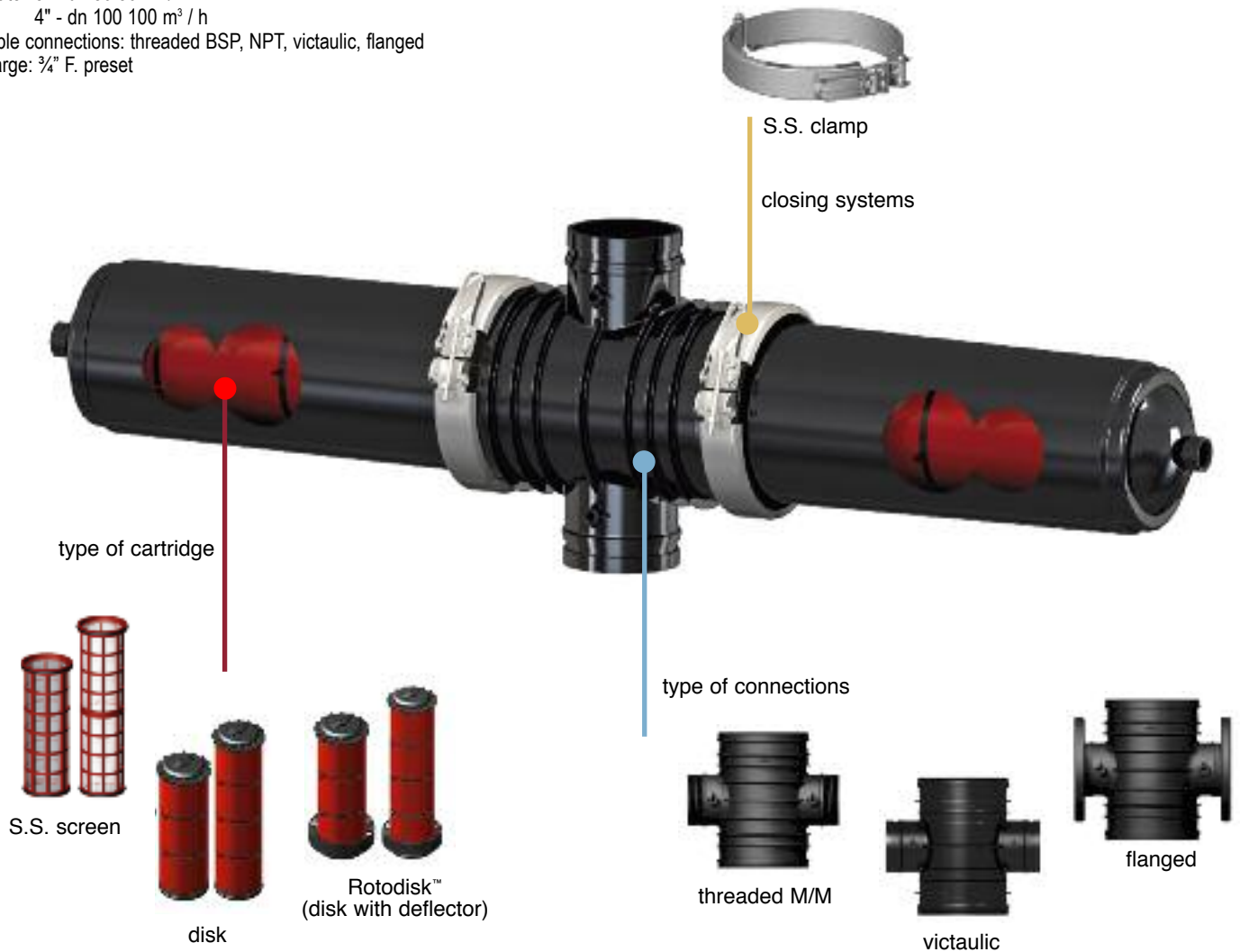
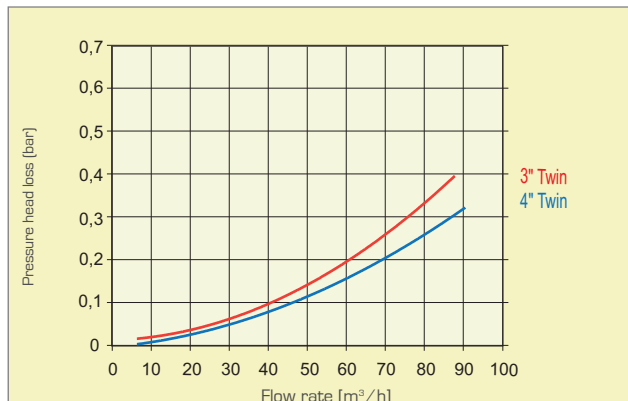

Table 1 - type of mesh

Ref.	mesh	micron	colour
H	75	200	tan
L	120	130	red
N	155	100	yellow





DHF



Twin filter 120 mesh\*  
model "H" with S.S. clamp



Ref.	G	connections	m³/h	cartridge	€	box	type	stock
IFDHFILM2F0N	3"	threaded	50	S.S. Screen	231,00	1	-	
IFDHFIDLM2F0N	3"	threaded	50	disk	231,00	1	-	
IFDHFIELM2F0N	3"	threaded	50	Rotodisk™	262,00	1	-	
IFDHFILW0F0N	3"	victaulic	50	S.S. Screen	231,00	1	-	
IFDHFIDLW0F0N	3"	victaulic	50	disk	231,00	1	-	
IFDHFIELW0F0N	3"	victaulic	50	Rotodisk™	262,00	1	-	
IFDHFILF0F0N	dn 80	flanged	50	S.S. Screen	264,00	1	-	
IFDHFIDLF0F0N	dn 80	flanged	50	disk	264,00	1	-	
IFDHFIELF0F0N	dn 80	flanged	50	Rotodisk™	297,00	1	-	

DIF



Twin filter 120 mesh\*  
model "I" with S.S. clamp



Ref.	G	connections	m³/h	cartridge	€	box	type	stock
IFDIFILM2F0N	4"	threaded	100	S.S. Screen	323,00	1	-	
IFDIFLDM2F0N	4"	threaded	100	disk	323,00	1	-	
IFDIFELM2F0N	4"	threaded	100	Rotodisk™	353,00	1	-	
IFDIFILW0F0N	4"	victaulic	100	S.S. Screen	323,00	1	-	
IFDIFLDLW0F0N	4"	victaulic	100	disk	323,00	1	-	
IFDIFLELW0F0N	4"	victaulic	100	Rotodisk™	353,00	1	-	
IFDIFLILF0F0N	dn 100	flanged	100	S.S. Screen	355,00	1	-	
IFDIFLDLF0F0N	dn 100	flanged	100	disk	355,00	1	-	
IFDIFLELF0F0N	dn 100	flanged	100	Rotodisk™	385,00	1	-	

\* = for other mesh see table 1

spare parts

description	fig.	type H		type I	
		Ref.	€	Ref.	€
Cap for S.S. clamp closing	1	0IFCLN*000000	34,60	0IFCNN*000000	47,20
Or cap	2	0IGCG00000000	1,89	0IGCG00000000	1,89
S.S. clamp	3	0FFTY00000000	50,50	0FFTY00000000	50,50
Complete S.S. cartridge	4	IIFMH20000I12	42,00	IIFMI20000I12	71,40
Complete disk cartridge	5	IITMH5000DI12	68,20	IITMI5000DI12	94,50
Complete Rotodisk™ cartridge	6	IITMH5E00DI12	89,20	IITMI5E00DI12	115,50
Body for clamp closing	7	0FD0**00M*00N	43,00	0FD0**00M*00N	43,00

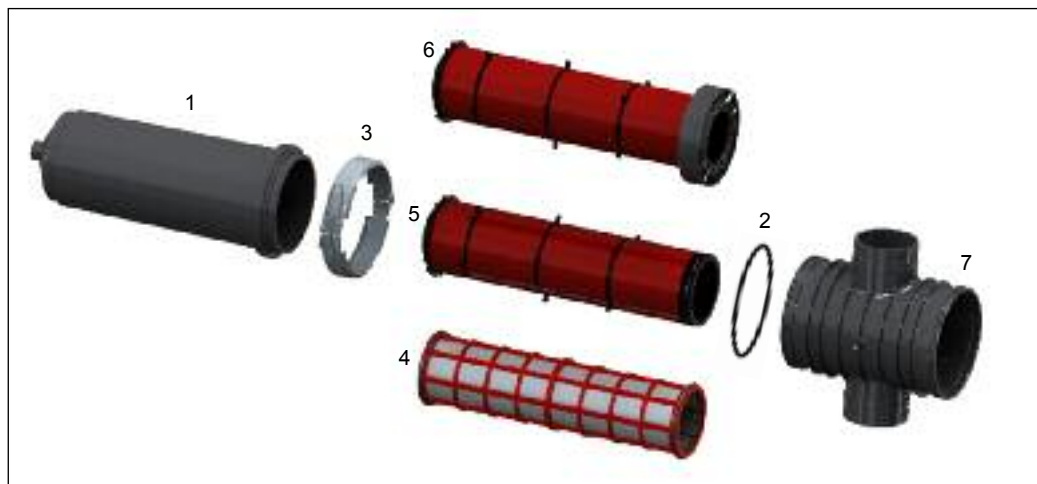

**ROTODISK™**  
A U T O M A T I C

**AUTOMATIC FILTER ROTODISK™**

The Automatic Rotodisk™ filter is a T filter manufactured with polyamide reinforced with fiber glass, provided with a special mechanical-hydraulic system for the automatic backwashing. The Automatic Rotodisk™ filters, when assembled as a battery of filters and used with suitable hydraulic valves and control unit, maintain a continuous irrigation cycle and reduce the waste of water and the maintenance of the filtering station. Available in single and double head (twin) with capacities ranging from 24 to 64 m³/h. The wide range of collectors available (from 3 "to 12") and the various possible configurations (from 2 to 14 filters) can reach capacities up to 640 m³/h.

**Characteristics**

Self-cleaning filter made of polyamide reinforced with fiber glass

Closing system: stainless steel clamp

Maximum working pressure: 10 bar at 20°C

Nominal flow rate:  
2" 24 m³/h  
3" 32 m³/h  
4" 64 m³/h

Filtering element: disk with deflector

Filtering surface:  
1400 cm² single head model  
2800 cm² double head model

Filtering grade: 75 - 120 - 155 mesh

Minimum backwashing pressure: 2,8 bar

Available connections: 2", 3" and 4 threaded BSP, NPT, Victaulic connections, mixed connections (threaded + Victaulic, in all combinations) DN 100 flanged DIN

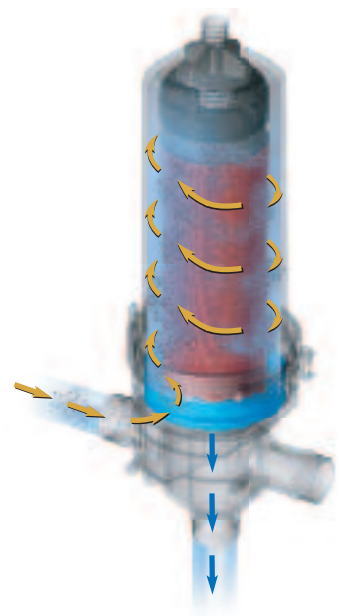

**Filtering**

Works like a normal manual filter. The external surface of the disks stops the suspended impurities allowing only the passage of the clean water.



**Backwashing**

the water, from the inside of the filtering cartridge, crossing small tangential holes, collides with the disks surface making them rotate and assuring a complete and effective cleaning.

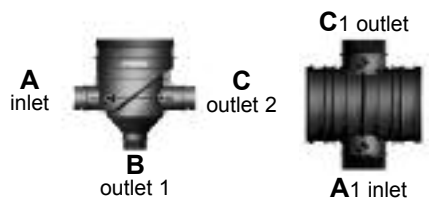
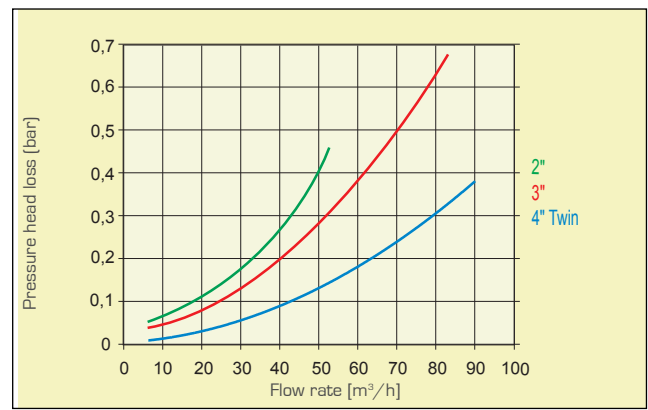

Table 1 - type of mesh

Ref.	mesh	micron	colour
H	75	200	tan
L	120	130	red
N	155	100	yellow

Table 2 - type of connections

Ref.	A	B	C	A1	C1
M2	BSP	BSP	BSP	BSP	BSP
V2	VIC	VIC	BSP	-	-
W2	VIC	BSP	VIC	-	-
M5	NPT	NPT	NPT	NPT	NPT
V5	VIC	VIC	NPT	-	-
W5	VIC	NPT	VIC	-	-
F0	-	-	-	DIN	DIN
W0	-	-	-	VIC	VIC



TAF



Automatic filter  
Rotodisk™ 120 mesh\*



Ref.	G	m³/h	€	box	type	stock
IFTAFGELxxFON	2"	24	600,00	1	T	
IFTAFIELxxFON	3"	32	620,00	1	T	

DAF



Automatic twin filter  
Rotodisk™ 120 mesh\*



Ref.	G	m³/h	€	box	type	stock
IFDAFLExxFOM	4"	64	1.300,00	1	-	

xx = specify type of connections (see tab. 2)

RSL

Automatic on-line filtration system  
with Rotodisk™ 2" 120 mesh\*



Ref.	filters	m³/h	D manifold	manifold	connections	discharge	€	type	stock
IFRSL201GBGRL	1	24	2"	steel	threaded	2" - 63	1.809,00	-	
IFRSL202IVPEL	2	48	3" - 90 mm	PE HD	Victaulic	2" - 63	3.330,00	V	
IFRSL202LVPEL	2	48	4" - 110 mm	PE HD	Victaulic	2" - 63	3.379,00	V	
IFRSL203LVPEL	3	72	4" - 110 mm	PE HD	Victaulic	2" - 63	4.446,00	V	
IFRSL204LVPEL	4	96	4" - 110 mm	PE HD	Victaulic	2" - 63	5.649,00	V	
IFRSL205PFPEL	5	120	6" - 160 mm	PE HD	flanged	2" - 63	6.736,00	V	
IFRSL206PFPEL	6	144	6" - 160 mm	PE HD	flanged	2" - 63	8.009,00	V	



RSL

Automatic on-line filtration system  
with Rotodisk™ 3" 120 mesh\*



Ref.	filters	m³/h	D manifold	manifold	connections	discharge	€	type	stock
IFRSL302LVPEL	2	64	4" - 110 mm	PE HD	Victaulic	3" - 90	3.759,00	V	
IFRSL303LVPEL	3	96	4" - 110 mm	PE HD	Victaulic	3" - 90	5.039,00	V	
IFRSL304PFPEL	4	128	6" - 160 mm	PE HD	flanged	3" - 90	6.424,00	V	
IFRSL305PFPEL	5	160	6" - 160 mm	PE HD	flanged	3" - 90	7.685,00	V	
IFRSL305RFPEL	5	160	8" - 200 mm	PE HD	flanged	3" - 90	7.899,00	V	
IFRSL306RFPEL	6	192	8" - 200 mm	PE HD	flanged	3" - 90	9.504,00	V	



RDL

Automatic on-line filtration system  
with Twin Rotodisk™ 4" 120 mesh\*



Ref.	filters	m³/h	D manifold	manifold	connections	discharge	€	type	stock
IFRDL403RVPEL	3	192	8" - 200 mm	PE HD	flanged	3" - 90	11.400,00	-	
IFRDL404RVPEL	4	256	8" - 200 mm	PE HD	flanged	3" - 90	11.400,00	-	
IFRDL405RVPEL	5	320	10" - 250 mm	PE HD	flanged	3" - 90	14.400,00	-	
IFRDL406RVPEL	6	384	10" - 250 mm	PE HD	flanged	3" - 90	18.950,00	-	
IFRDL407RVPEL	7	448	10" - 250 mm	PE HD	flanged	3" - 90	20.900,00	-	
IFRDL408RVPEL	8	512	12" - 315 mm	PE HD	flanged	3" - 90	24.700,00	-	
IFRDL409RVPEL	9	576	12" - 315 mm	PE HD	flanged	3" - 90	26.400,00	-	
IFRDL410RVPEL	10	640	12" - 315 mm	PE HD	flanged	3" - 90	29.850,00	-	



RSP

Automatic filtration system in parallel  
with Rotodisk™ 3" 120 mesh\*



Ref.	filters	m³/h	D manifold	manifold	connections	discharge	€	type	stock
IFRSP310RFGR	10	320	8" - 200	steel epoxy coated	flanged	3" - 90	14.706,00	V	
IFRSP312TFGR	12	384	10" - 250	steel epoxy coated	flanged	3" - 90	18.689,00	V	
IFRSP314TFGR	14	448	10" - 250	steel epoxy coated	flanged	3" - 90	21.373,00	V	

\* = for other mesh see table 1

All the filtration systems are supplied complete with automation

ESV



on line filter with stainless steel + polyester screen cartridge



Ref.	G - dn	connections	m³/h	€	box	stock
IFESV20H12	2" *	F. thread	15÷30	245,00	1	<input type="checkbox"/>
IFESV30H12	3" *	F. thread	25÷40	293,70	1	<input type="checkbox"/>
IFESV30F12	dn 80	flanged	25÷40	306,00	1	<input type="checkbox"/>
IFESV40H12	4" *	F. thread	40÷80	347,00	1	<input type="checkbox"/>
IFESV40F12	dn 100	flanged	40÷80	382,00	1	<input type="checkbox"/>
IFESV50F12	dn 125	flanged	80÷110	430,00	1	<input type="checkbox"/>
IFESV60F12	dn 150 *	flanged	110÷150	700,00	1	<input type="checkbox"/>

ESV 90°



90° on line filter with stainless steel + polyester screen cartridge



Ref.	G - dn	connections	m³/h	€	box	stock
IFESV9020H12	2" *	F. thread	15÷30	223,00	1	<input type="checkbox"/>
IFESV9030H12	3" *	F. thread	25÷40	273,00	1	<input type="checkbox"/>
IFESV9040H12	4" *	F. thread	40÷80	361,00	1	<input type="checkbox"/>
IFESV9060F12	dn 150 *	flanged	110÷150	665,00	1	<input type="checkbox"/>

EPV



on line filter with pvc + stainless steel screen



Ref.	G - dn	connections	m³/h	€	box	stock
IFEPV20H12	2" *	F. thread	15÷30	230,00	1	<input type="checkbox"/>
IFEPV30H12	3" *	F. thread	25÷40	278,00	1	<input type="checkbox"/>
IFEPV30F12	dn 80	flanged	25÷40	295,00	1	<input type="checkbox"/>
IFEPV40H12	4" *	F. thread	40÷80	395,00	1	<input type="checkbox"/>
IFEPV40F12	dn 100	flanged	40÷80	415,00	1	<input type="checkbox"/>
IFEPV60F12	dn 150 *	flanged	110÷150	720,00	1	<input type="checkbox"/>

EPV 90°



90° on line filter with pvc + stainless steel screen



Ref.	G - dn	connections	m³/h	€	box	stock
IFEPV9020H12	2" *	F. thread	15÷30	205,00	1	<input type="checkbox"/>
IFEPV9030H12	3" *	F. thread	25÷40	265,00	1	<input type="checkbox"/>
IFEPV9040H12	4" *	F. thread	40÷80	410,00	1	<input type="checkbox"/>
IFEPV9060F12	dn 150 *	flanged	110÷150	710,00	1	<input type="checkbox"/>

EDV



on line disk filters



Ref.	G - dn	connections	m³/h	€	box	stock
IFEDV20H12	2" *	F. thread	15÷30	213,00	1	<input type="checkbox"/>
IFEDV30H12	3" *	F. thread	25÷40	270,00	1	<input type="checkbox"/>
IFEDV30F12	dn 80	flanged	25÷40	295,00	1	<input type="checkbox"/>
IFEDV40H12	4" *	F. thread	40÷80	310,00	1	<input type="checkbox"/>
IFEDV40F12	dn 100	flanged	40÷80	325,00	1	<input type="checkbox"/>

EDV 90°



90° disk filters



Ref.	G - dn	connections	m³/h	€	box	stock
IFEDV9020H12	2" *	F. thread	15÷30	200,00	1	<input type="checkbox"/>
IFEDV9030H12	3" *	F. thread	25÷40	250,00	1	<input type="checkbox"/>
IFEDV9040H12	4" *	F. thread	40÷80	285,00	1	<input type="checkbox"/>

ETV



on line self cleaning screen filter



Ref.	G - dn	connections	m³/h	€	box	stock
IFETV20H12	2" *	F. thread	11÷31	334,80	1	<input type="checkbox"/>
IFETV30H12	3" *	F. thread	12÷40	371,00	1	<input type="checkbox"/>
IFETV30F12	dn 80	flanged	12÷40	383,00	1	<input type="checkbox"/>
IFETV40H12	4" *	F. thread	20÷70	498,00	1	<input type="checkbox"/>
IFETV40F12	dn 100	flanged	20÷70	553,00	1	<input type="checkbox"/>

EBV



on line self cleaning screen filter with brush



Ref.	G - dn	connections	m³/h	€	box	stock
IFEBV20H12	2" *	F. thread	11÷31	375,00	1	<input type="checkbox"/>
IFEBV30H12	3" *	F. thread	12÷40	400,00	1	<input type="checkbox"/>
IFEBV30F12	dn 80	flanged	12÷40	425,00	1	<input type="checkbox"/>
IFEBV40H12	4" *	F. thread	20÷70	570,00	1	<input type="checkbox"/>
IFEBV40F12	dn 100	flanged	20÷70	595,00	1	<input type="checkbox"/>

\* available also with victaulic connection

spare parts

description	2"		3" - dn 80		4" - dn 100		dn 125		dn 150	
	Ref.	€	Ref.	€	Ref.	€	Ref.	€	Ref.	€
PVC Cartridge with S.S. screen 120 mesh EPV	IF90EP630L	60,00	IF90EP900L	85,00	IF90EP110L	118,00	IF90EP125L	150,00	IF90EP140L	260,00
S.S. + Poly screen cartridge (complete) ESV	IF90ES630	50,00	IF90ES900	68,00	IF90ES110	75,00	IF90ES125	86,00	IF90ES140	130,00
Polyester screen 120 mesh ESV	OF60146120	15,00	OF60146120	15,00	OF60146120	15,00	OF60146120	15,00	OF60146120	15,00
S.S.Cartridge 120 mesh ETV - EBV	IF90ET630L	125,00	IF90ET900L	148,00	IF90ET110L	165,00	IF90ET125L	-	IF90ET140L	-
Body gasket	OF620168B	9,00	OF620168B	9,00	OF620219B	10,00	OF620219B	10,00	OF620219B	10,00
Cap gasket	OF620168B	9,00	OF620168B	9,00	OF620219B	10,00	OF620219B	10,00	OF620219B	10,00

ERV



double chamber sand media filter  
complete with gate valve for  
the manual backwashing  
(discharge 2" - 63)



Ref.	D body	G - dn	connections	m³/h	€	sand	stock
IFERV15H	400 mm	1" ½	F. thread	5÷11	<b>910,00</b>	60 kg	
IFERV20H	500 mm	2"	F. thread	10÷30	<b>1.410,00</b>	120 kg	

ER3V



double chamber sand media filter  
complete with 3 way valves for  
the manual backwashing  
(discharge 2" - 63)



Ref.	D body	G - dn	connections	m³/h	€	sand	stock
IFER3V30H	600 mm	3"	F. thread	30÷60	<b>1.848,00</b>	200 kg	
IFER3V30F	600 mm	dn 80	flanged	30÷60	<b>1.881,00</b>	200 kg	
IFER3V40H	750 mm	4"	F. thread	40÷80	<b>2.365,00</b>	300 kg	
IFER3V40F	750 mm	dn 100	flanged	40÷80	<b>2.398,00</b>	300 kg	
IFER3V50F	850 mm	dn 125	flanged	70÷110	<b>3.443,00</b>	600 kg	

EGV



sand media filter with diffusers



Ref.	D body	G - dn	connections	m³/h	€	sand	stock
IFEGV20H600	600 mm	2" *	F. thread	14÷28	<b>755,00</b>	150 kg	
IFEGV30H600	600 mm	3" *	F. thread	14÷28	<b>784,00</b>	150 kg	
IFEGV30H900	900 mm	3" *	F. thread	32÷62	<b>1.000,00</b>	350 kg	
IFEGV30F900	900 mm	dn 80	flanged	32÷62	<b>1.040,00</b>	350 kg	
IFEGV40H900	900 mm	4" *	F. thread	35÷65	<b>1.060,00</b>	350 kg	
IFEGV40F900	900 mm	dn 100	flanged	35÷65	<b>1.100,00</b>	350 kg	
IFEGV40H1200	1200 mm	4" *	F. thread	35÷90	<b>1.750,00</b>	800 kg	
IFEGV40F1200	1200 mm	dn 100	flanged	35÷90	<b>1.810,00</b>	800 kg	

\* available also with victaulic connection

EHV



sand media filter with collectors



Ref.	D body	G - dn	connections	m³/h	€	sand	stock
IFEHV30H750	750 mm	2" *	F. thread	21÷42	<b>760,00</b>	200 kg	
IFEHV30H900	900 mm	3" *	F. thread	32÷62	<b>860,00</b>	350 kg	
IFEHV30F900	900 mm	dn 80	flanged	32÷62	<b>900,00</b>	350 kg	
IFEHV40H1200	1200 mm	4" *	F. thread	35÷90	<b>1.620,00</b>	800 kg	
IFEHV40F1200	1200 mm	dn 100	flanged	35÷90	<b>1.690,00</b>	800 kg	

KAS

complete automation Kit  
for double chamber filter ER3V



Ref.	suitable for	€	box	stock
IFKAS:02D	all models ER3V	*	1	

x = specify controller power: **A** 220VAC - **B** 9-30 VDC - **L** battery

\* on request

GRA

quartzite sand



Ref.	granulometry mm.	bags kg.	€	box	stock
IFGRA0812	0,8÷1,2	25	<b>0,70</b>	-	
IFGRA1015	1,0÷1,5	25	<b>0,70</b>	-	
IFGRA1525	1,5÷2,5	25	<b>0,70</b>	-	

spare parts

description	1" ½-2" (500)		2"-3" (600 - 750)		3"/dn 80 - 4"/dn 100 (900)		4" - dn 100 (1200)		dn 125	
	Ref.	€	Ref.	€	Ref.	€	Ref.	€	Ref.	€
Gasket for loading hatchway ERV - ER3V	0F62F12F	<b>9,50</b>	0F62F12F	<b>9,50</b>	0F62F12F	<b>9,50</b>	0F62F12F	<b>9,50</b>	0F62F12F	<b>9,50</b>
Gasket for discharge hatchway ERV	0F62F12F	<b>9,50</b>	0F62F12F	<b>9,50</b>	0F62F12F	<b>9,50</b>	0F62F12F	<b>9,50</b>	0F62F12F	<b>9,50</b>
Gasket for loading hatchway EGV - EHV	0F620168C	<b>7,00</b>	0F620168C	<b>7,00</b>	0F62F12F	<b>7,00</b>	0F62F12F	<b>7,00</b>	-	-
Gasket for discharge hatchway EGV	0F620168C	<b>7,00</b>	0F620168C	<b>7,00</b>	0F62F12F	<b>7,00</b>	0F62F12F	<b>7,00</b>	-	-
Diffusers	0F56000	<b>1,50</b>	0F56000	<b>1,50</b>	0F56000	<b>1,50</b>	0F56000	<b>1,50</b>	0F56000	<b>1,70</b>
Rubber for D diffuser	0F56GOM2U	<b>1,30</b>	0F56GOM2U	<b>1,30</b>	0F56GOM2U	<b>1,30</b>	0F56GOM2U	<b>1,30</b>	0F56GOM2U	<b>1,30</b>
100mm 1" collector	-	-	0F3200100D	<b>1,70</b>	0F3200100D	<b>1,70</b>	0F3200100D	<b>1,70</b>	-	-
160mm 1" collector	-	-	0F3200160D	<b>1,90</b>	0F3200160D	<b>1,90</b>	0F3200160D	<b>1,90</b>	-	-
225mm 1" collector	-	-	0F3200225D	<b>1,90</b>	0F3200225D	<b>1,90</b>	0F3200225D	<b>1,90</b>	-	-
Coupling for collector	-	-	0F3300000D	<b>1,40</b>	0F3300000D	<b>1,40</b>	0F3300000D	<b>1,40</b>	-	-

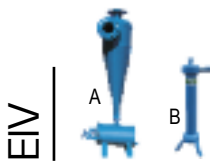

hydro-cyclone sand separator with tank



Ref.	version	G - dn	connections	m³/h	€	box	stock
IFEIV03H	B	¾"	F. thread	3+5	174,00	1	<input type="checkbox"/>
IFEIV10H	B	1"	F. thread	5+12	189,80	1	<input type="checkbox"/>
IFEIV15H	B	1" ½	F. thread	10+16	197,80	1	<input type="checkbox"/>
IFEIV20H219	A	2"	F. thread	15+25	369,60	1	<input type="checkbox"/>
IFEIV30H219	A	3"	F. thread	30+50	385,00	1	<input type="checkbox"/>
IFEIV30H320	A	3"	F. thread	40+60	498,00	1	<input type="checkbox"/>
IFEIV30F320	A	dn 80	flanged	40+60	522,00	1	<input type="checkbox"/>
IFEIV40H320	A	4"	F. thread	50+80	518,00	1	<input type="checkbox"/>
IFEIV40F320	A	dn 100	flanged	50+80	545,00	1	<input type="checkbox"/>



simple filter system  
 • Hydro-cyclone separator  
 • screen filter  
 • fertigation kit



Ref.	model	G	connections	m³/h	€	stock
IFETS120H	EIV + ESV + KIT	2"	F. thread	15+30	998,00	<input type="checkbox"/>
IFETS130H	EIV + ESV + KIT	3"	F. thread	25+40	1.203,00	<input type="checkbox"/>
IFETS140H	EIV + ESV + KIT	4"	F. thread	40+80	1.799,00	<input type="checkbox"/>
IFETS220H	EIV + EDV + KIT	2"	F. thread	15+30	1.010,00	<input type="checkbox"/>
IFETS230H	EIV + EDV + KIT	3"	F. thread	25+40	1.298,00	<input type="checkbox"/>
IFETS240H	EIV + EDV + KIT	4"	F. thread	40+80	2.002,00	<input type="checkbox"/>
IFETS320H	EIV + ETV + KIT	2"	F. thread	11+31	1.033,00	<input type="checkbox"/>
IFETS330H	EIV + ETV + KIT	3"	F. thread	12+40	1.350,00	<input type="checkbox"/>
IFETS340H	EIV + ETV + KIT	4"	F. thread	20+70	2.070,00	<input type="checkbox"/>



basic group assembly with single camera sand media filter, outlet screen filter, manifold, manual valves for backwash, accessories



Ref.	m³/h	model	filters	G - dn	connections	€	stock
* IFGBV6202SIHI	40	600 mm - 2"	2	3"	F. thread	3.326,00	<input type="checkbox"/>
* IFGBV6303SLHI	65	600 mm - 3"	3	4"	F. thread	4.633,00	<input type="checkbox"/>
* IFGBV6304SLHI	80	600 mm - 3"	4	4"	F. thread	6.247,00	<input type="checkbox"/>
* IFGBV6305SPFI	100	600 mm - 3"	5	dn 150	flanged	7.700,00	<input type="checkbox"/>
* IFGBV9302SLHI	80	900 mm - 3"	2	4"	F. thread	4.428,00	<input type="checkbox"/>
* IFGBV9303SPFI	120	900 mm - 3"	3	dn 150	flanged	7.884,00	<input type="checkbox"/>
* IFGBV9304SPFI	160	900 mm - 3"	4	dn 150	flanged	11.944,00	<input type="checkbox"/>
* IFGBV9305SPFI	200	900 mm - 3"	5	dn 150	flanged	14.515,00	<input type="checkbox"/>

Basic group assembly with single camera sand media filter, outlet screen filter, manifold, backwash valves, controller and accessories



Ref.	m³/h	model	filters	G - dn	connections	€	stock
* IFGCV6202SIHI	40	600 mm - 2"	2	3"	F. thread	5.427,00	<input type="checkbox"/>
* IFGCV6303SLHI	65	600 mm - 3"	3	4"	F. thread	7.673,00	<input type="checkbox"/>
* IFGCV6304SLHI	80	600 mm - 3"	4	4"	F. thread	9.666,00	<input type="checkbox"/>
* IFGCV6305SPFI	100	600 mm - 3"	5	dn 150	flanged	12.506,00	<input type="checkbox"/>
* IFGCV9302SLHI	80	900 mm - 3"	2	4"	F. thread	6.291,00	<input type="checkbox"/>
* IFGCV9303SPFI	120	900 mm - 3"	3	dn 150	flanged	10.434,00	<input type="checkbox"/>
* IFGCV9304SPFI	160	900 mm - 3"	4	dn 150	flanged	14.877,00	<input type="checkbox"/>
* IFGCV9305SPFI	200	900 mm - 3"	5	dn 150	flanged	18.878,00	<input type="checkbox"/>



\* The group is supplied disassembled and without sand

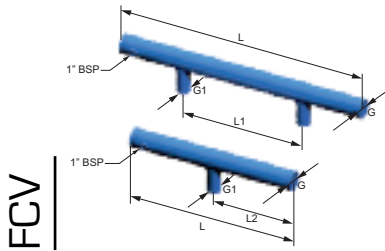

manifold side output



Ref.	way	G	G1	L	L1	L2	€	stock
IFFCV04011V2V	1	3"	2"	800	-	400	140,00	
IFFCV08021V2V	2	3"	2"	1.600	800	-	238,00	
IFFCV04011LV2V	1	4"	2"	800	-	400	152,00	
IFFCV08021LV2V	2	4"	2"	1.600	800	-	284,00	
IFFCV04011LV3V	1	4"	3"	800	-	400	166,00	
IFFCV08021LV3V	2	4"	3"	1.600	800	-	313,00	
IFFCV04011PV2V	1	6"	2"	800	-	400	211,00	
IFFCV08021PV2V	2	6"	2"	1.600	800	-	413,00	
IFFCV04011PV3V	1	6"	3"	800	-	400	224,00	
IFFCV08021PV3V	2	6"	3"	1.600	800	-	445,00	
IFFCV04018V2V	1	8"	2"	800	-	400	263,00	
IFFCV08028V2V	2	8"	2"	1.600	800	-	524,00	
IFFCV04018V3V	1	8"	3"	800	-	400	276,00	
IFFCV08028V3V	2	8"	3"	1.600	800	-	539,00	
IFFCV06011LV3V	1	4"	3"	1.200	-	600	281,00	
IFFCV12021LV3V	2	4"	3"	2.400	1.200	-	521,00	
IFFCV06011PV3V	1	6"	3"	1.200	-	600	333,00	
IFFCV12021PV3V	2	6"	3"	2.400	1.200	-	658,00	
IFFCV06011PV4V	1	6"	4"	1.200	-	600	351,00	
IFFCV12021PV4V	2	6"	4"	2.400	1.200	-	674,00	
IFFCV06018V3V	1	8"	3"	1.200	-	600	415,00	
IFFCV12028V3V	2	8"	3"	2.400	1.200	-	812,00	
IFFCV06018V4V	1	8"	4"	1.200	-	600	432,00	
IFFCV12028V4V	2	8"	4"	2.400	1.200	-	833,00	
IFFCV06611PV4V	1	6"	4"	1.320	-	660	386,00	
IFFCV13221PV4V	2	6"	4"	2.640	1.320	-	741,00	
IFFCV06618V4V	1	8"	4"	1.320	-	660	454,00	
IFFCV13228V4V	2	8"	4"	2.640	1.320	-	884,00	

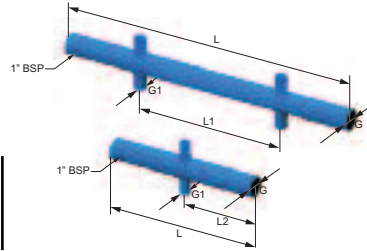

manifold opposite output



Ref.	way	G	G1	L	L1	L2	€	stock
IFFDV04021V2V	1	3"	2"	800	-	400	152,00	
IFFDV08021V2V	2	3"	2"	1.600	800	-	258,00	
IFFDV04011LV2V	1	4"	2"	800	-	400	165,00	
IFFDV08021LV2V	2	4"	2"	1.600	800	-	308,00	
IFFDV04011LV3V	1	4"	3"	800	-	400	181,00	
IFFDV08021LV3V	2	4"	3"	1.600	800	-	340,00	
IFFDV04011PV2V	1	6"	2"	800	-	400	229,00	
IFFDV08021PV2V	2	6"	2"	1.600	800	-	448,00	
IFFDV04011PV3V	1	6"	3"	800	-	400	243,00	
IFFDV08021PV3V	2	6"	3"	1.600	800	-	483,00	
IFFDV04018V2V	1	8"	2"	800	-	400	286,00	
IFFDV08028V2V	2	8"	2"	1.600	800	-	569,00	
IFFDV04018V3V	1	8"	3"	800	-	400	300,00	
IFFDV08028V3V	2	8"	3"	1.600	800	-	585,00	
IFFDV06011LV3V	1	4"	3"	1.200	-	600	306,00	
IFFDV12021LV3V	2	4"	3"	2.400	1.200	-	566,00	
IFFDV06011PV3V	1	6"	3"	1.200	-	600	362,00	
IFFDV12021PV3V	2	6"	3"	2.400	1.200	-	715,00	
IFFDV06011PV4V	1	6"	4"	1.200	-	600	381,00	
IFFDV12021PV4V	2	6"	4"	2.400	1.200	-	731,00	
IFFDV06018V3V	1	8"	3"	1.200	-	600	451,00	
IFFDV12028V3V	2	8"	3"	2.400	1.200	-	881,00	
IFFDV06018V4V	1	8"	4"	1.200	-	600	469,00	
IFFDV12028V4V	2	8"	4"	2.400	1.200	-	905,00	
IFFDV06611PV4V	1	6"	4"	1.320	-	660	420,00	
IFFDV13221PV4V	2	6"	4"	2.640	1.320	-	805,00	
IFFDV06618V4V	1	8"	4"	1.320	-	660	493,00	
IFFDV13228V4V	2	8"	4"	2.640	1.320	-	960,00	

M10



flanged adaptor/victaulic



Ref.	dn x G	L	€	pack	box	stock
IFM10V03F03V	dn 80 x 3"	150	52,40	1	-	
IFM10V04F04V	dn 100 x 4"	150	75,00	1	-	
IFM10V06F06V	dn 150 x 6"	150	117,00	1	-	
IFM10V08F08V	dn 200 x 8"	150	147,00	1	-	

M11



flanged adaptor /female thread



Ref.	dn x G	L	€	pack	box	stock
IFM11V03F03H	dn 80 x 3"	100	38,00	1	-	
IFM11V04F04H	dn 100 x 4"	100	48,00	1	-	
IFM11V05F05H	dn 125 x 5"	100	67,00	1	-	

M16



flanged adaptor /flanged



Ref.	dn x dn	L	€	pack	box	stock
IFM16V04F03F	dn 100 x dn 80	150	77,00	1	-	
IFM16V05F04F	dn 125 x dn 100	150	94,00	1	-	
IFM16V06F05F	dn 150 x dn 125	150	148,00	1	-	

M21



victaulic adaptor / female thread



Ref.	G x G	L	€	pack	box	stock
IFM21V02H02V	2" x 2"	150	13,50	1	-	
IFM21V03H03V	3" x 3"	150	15,30	1	-	
IFM21V04H04V	4" x 4"	150	16,00	1	-	

M14



victaulic plug



Ref.	G	L	€	pack	box	stock
IFM14V02	2"	100	17,00	1	-	
IFM14V03	3"	100	21,00	1	-	
IFM14V04	4"	100	25,00	1	-	
IFM14V06	6"	100	48,00	1	-	
IFM14V08	8"	100	50,00	1	-	

VIC



victaulic coupling



Ref.	G	model	€	pack	box	stock
IYVICG0000630	2"	cast iron	6,60	1	-	
IYVICG0000900	3"	cast iron	10,30	1	-	
IYVICG000090G	3" x 2"	cast iron	19,00	1	-	
IYVICG0000110	4"	cast iron	16,00	1	-	
IYVICG0000111	4" x 3"	cast iron	32,00	1	-	
IYVICG0000160	6"	cast iron	22,00	1	-	
IYVICG000016L	6" x 4"	cast iron	52,00	1	-	
IYVICG0000200	8"	cast iron	35,00	1	-	
IYVICG000020P	8" x 6"	cast iron	78,00	1	-	

VIF



victaulic coupling with flange



Ref.	G x dn	model	€	pack	box	stock
IYVIFG0000180	3" x dn 80	cast iron	29,00	1	-	
IYVIFG0000L10	4" x dn 100	cast iron	33,00	1	-	

VCL



3 way valve in-line for filter backwash



Ref.	D	connections	€	pack	box	stock
IAVCL00000263	2"x 2"x 2"	threadeds	167,00	1	-	
IAVCL00000363	2"x 2"x 2"	victaulic	167,00	1	-	
IAVCL00000290	3"x 3"x 3"	threadeds	265,00	1	-	
IAVCL00000390	3"x 3"x 3"	victaulic	265,00	1	-	

VC9



3 way valve 90° for filter backwash



Ref.	D	connections	€	pack	box	stock
IAVC900000263	2"x 2"x 2"	threadeds	176,00	1	-	
IAVC900000363	2"x 2"x 2"	victaulic	176,00	1	-	
IAVC900000290	3"x 3"x 3"	threadeds	278,00	1	-	
IAVC900000390	3"x 3"x 3"	victaulic	278,00	1	-	

FILTER



controller for filter backwash "FILTER"



Ref.	zone	power supply	€	pack	box	stock
ICCFLA2202	2	220 VAC	476,00	1	-	
ICCFLA2206	6	220 VAC	600,00	1	-	
ICCFLB0302	2	9-30 VDC	453,00	1	-	
ICCFLB0306	6	9-30 VDC	572,00	1	-	

TIC



controller for filter backwash "TIC"



Ref.	zone	power supply	€	pack	box	stock
IFPCL02CC12	2	batteries	250,00	1	-	
IFPCL04CC12	4	batteries	280,00	1	-	

G 75A



1/8" solenoid valve



Ref.	model	power supply	€	pack	box	stock
IBG75A110x21	plastic	24 VAC	*	1	-	
IBG75A110x23	plastic	12 VDC	*	1	-	
IBG75A110x22	plastic	9-12 VDC latch	*	1	-	

\* See page 44

x = 3 nc - 4 no

G 75P



GALIT pilot 1/8"



Ref.	model	power supply	€	pack	box	stock
IBG75P101	plastic	24 VAC	*	1	-	
IBG75P102	plastic	9-12 VDC latch	*	1	-	
IBG75P104	plastic	12 VDC	*	1	-	



pressure differential



Ref.	model	€	pack	box	stock
IBG75DP1	digital	183,00	1	-	
IAPDF00	analogic	302,00	1	-	

PGG



glycerine pressure gauge



Ref.	scale	€	pack	box	type	stock
IIPGG00000025	0÷2,5	10,20	1	100	-	
IIPGG00000060	0÷6,0	10,20	1	100	-	
IIPGG00000100	0÷10	10,20	1	100	-	





	page
Venturi Injectors - Fertilizer injectors	34
Dosmatic® proportional injectors	35
Fertigation benches	36
Hydraulic/electric pumps - Agitators	37
Fertigation accessories	38
Controllers	39
Baccara Electric valves and controllers	40
Hydraulic valves	41
Water meters - Hydraulic valves accessories	42





fertilizing tank

Ref.	capacity	model	€	box	stock
IFEFV06V	60	vertical	378,00	1	
IFEFV08V	80	vertical	486,00	1	
IFEFV12V	120	vertical	513,50	1	
IFEFV20V	200	vertical	495,90	1	
IFEFV200	200	horizontal	552,40	1	
IFEFV400	400	horizontal	790,60	1	



by-pass for fertilizer tank

Ref.	G	connections	G1	€	box	stock
IFEKV20HC	2"	F. thread	3/4"	81,00	1	
IFEKV30HC	3"	F. thread	3/4"	131,00	1	
IFEKV40HC	4"	F. thread	3/4"	183,00	1	



Venturi injector mod. "Pro" without accessories

Ref.	G	suction l/h	€	pack	box	type	stock
IJIVP50M0V25B	3/4"	150	23,50	1	40	C	
IJIVP50M0V32C	1"	350	30,50	1	16	C	
IJIVP50M0V50B	1" 1/2	700	63,50	1	8	C	
IJIVP50M0V63B	2"	1800	77,00	1	5	C	

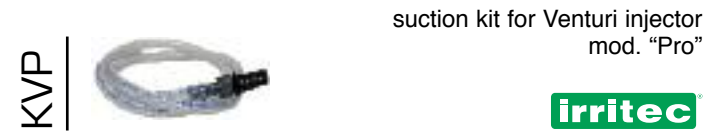

suction kit for Venturi injector mod. "Pro"

Ref.	D	suitable for Venturi	€	pack	box	type	stock
IJKVP000000C	-	3/4"	9,00	1	10	C	
IJKVP000000DF	-	1" - 1" 1/2	9,70	1	8	C	
IJKVP000000G	-	2"	25,00	1	5	B	

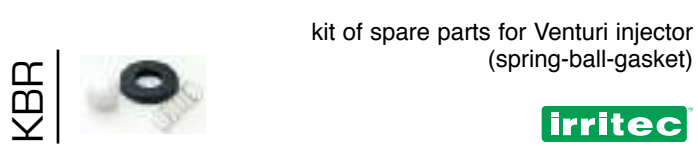

kit of spare parts for Venturi injector (spring-ball-gasket)

Ref.	D	suitable for Venturi	€	pack	box	type	stock
IJKBR000000C	-	3/4"	5,00	1	-	-	
IJKBR000000DF	-	1" - 1" 1/2	7,00	1	-	-	



flow meter

Ref.	G	model	€	pack	box	stock
IJFLFB9C0120	1/2"	15/160 l/h	96,00	1	1	
IJFLFB9C0300	1/2"	30/300 l/h	96,00	1	1	
IJFLFB9C0500	1/2"	50/500 l/h	96,00	1	1	
IJFLFB9M0750	1/2"	15/160 l/h	96,00	1	1	
IJFLFB9V1000	1/2"	250/1000 l/h	96,00	1	1	
IJFLFC9P1200	3/4"	150/1200 l/h	131,00	1	1	

characteristics Venturi mod. "Pro"

inlet pressure (bar)	outlet pressure (bar)	Ø 3/4"		Ø 1"		Ø 1 1/2"		Ø 2"	
		inlet flow rate (l/min)	Suction (l/h)	inlet flow rate (l/min)	Suction (l/h)	inlet flow rate (l/min)	Suction (l/h)	inlet flow rate (l/min)	Suction (l/h)
0,35	0,00	8	94	26	360	54	590	160	2130
	0,10	8	92	23	198	45	294	140	1570
	0,20	8	82	21	84	43	200	122	505
	0,28	7	32	-	na	-	na	113	175
	0,30	-	na	-	na	-	na	-	na
0,70	0,00	11	91	36	372	74	720	200	2220
	0,40	11	88	31	144	64	450	190	2200
	0,50	11	43	31	90	58	108	162	522
	0,60	10	30	-	na	-	na	160	10
1,00	0,00	14	90	40	354	83	720	230	2040
	0,40	14	88	39	270	74	483	225	2040
	0,70	13	44	37	108	70	180	195	600
	0,84	13	35	-	na	-	na	-	na
1,40	0,00	16	80	47	336	93	720	256	1980
	0,35	16	80	47	336	90	642	256	1980
	0,70	15	77	46	264	86	440	238	1386
	1,00	15	47	45	126	83	204	226	642
2,10	0,00	19	82	56	312	110	700	330	1980
	0,35	19	82	56	312	110	700	310	1980
	0,70	19	80	56	312	110	678	314	1980
	1,00	19	79	56	312	108	600	307	1740
	1,40	18	59	54	204	104	390	300	1080
	1,70	18	34	53	36	99	70	290	270

inlet pressure (bar)	outlet pressure (bar)	Ø 3/4"		Ø 1"		Ø 1 1/2"		Ø 2"	
		inlet flow rate (l/min)	Suction (l/h)	inlet flow rate (l/min)	Suction (l/h)	inlet flow rate (l/min)	Suction (l/h)	inlet flow rate (l/min)	Suction (l/h)
3,10	0,00	24	83	66	300	131	700	358	1950
	0,35	24	83	66	300	131	700	358	1950
	0,70	24	83	66	300	131	700	357	1950
	1,00	24	83	66	300	131	700	357	1950
	1,70	24	75	66	300	130	630	353	1650
	2,00	23	61	66	282	127	504	344	1314
	2,40	23	43	65	123	124	213	337	534
4,10	0,00	27	85	77	300	134	700	450	1950
	2,00	27	81	77	300	134	700	440	1950
	2,40	27	77	77	300	134	612	394	1740
	3,00	26	47	76	230	132	324	386	1050
5,5	3,24	26	26	-	na	132	168	380	500
	0,00	32	84	90	300	159	720	460	1950
	2,06	32	84	90	300	159	720	460	1950
	3,10	32	81	90	300	158	708	460	1884
	4,10	31	60	90	255	156	378	445	1104
6,9	4,48	31	26	89	84	154	132	440	276
	0,00	35	93	95	300	178	720	530	1950
	2,75	35	93	95	300	178	720	530	1950
	4,50	35	81	95	300	177	660	530	1950
	5,20	34	68	94	234	175	384	510	1308
	5,44	34	55	94	147	174	240	510	888

\* When assembled with aspiration kit the above mentioned values decrease of 5%

DSM



proportional injector



Ref.	model	l/h	dosing	€	box	stock
IIDSM000MCD2	MicroDos 2,5%	45 - 680	1,0% - 2,5%	<b>414,00</b>	1	
IIDSM000MCD5	MicroDos 5%	45 - 680	2,0% - 5,0%	<b>414,00</b>	1	
IIDSM000MND1	MiniDos 1%	6,6 - 2700	0,2% - 1,0%	<b>500,00</b>	1	
IIDSM000MND2	MiniDos 2,5%	6,6 - 2700	0,5% - 2,5%	<b>548,10</b>	1	
IIDSM000MND5	MiniDos 5%	6,6 - 2700	1,0% - 5,0%	<b>661,50</b>	1	
IIDSM000MND10	MiniDos 10%	15 - 2280	2,0% - 10%	<b>714,00</b>	1	
IIDSM0000S302	SuperDos 30 2,5%	30 - 6800	0,2% - 2,5%	<b>793,40</b>	1	
IIDSM0000S305	SuperDos 30 5%	30 - 6800	0,4% - 5,0%	<b>874,00</b>	1	
IIDSM0000S452	SuperDos 45 2,5%	113 - 10000	0,2% - 2,5%	<b>888,00</b>	1	
IIDSM0000T1D1	T100x2 1%	4560 - 22700	1,0% - 2,0%	<b>2.950,00</b>	1	
IIDSM0000T2D1	T200x2 0,5%	9100 - 45400	0,5% - 1,0%	<b>3.950,00</b>	1	

UNM



mobile unit for  
proportional injector



Ref.	€	pack	box	stock
IIDSM00000UNM	<b>530,00</b>	1	1	

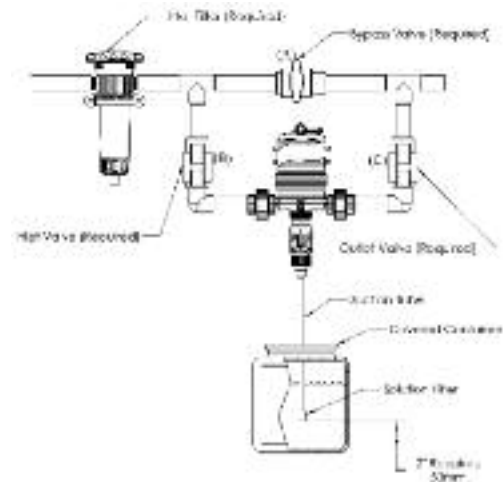

spare parts for proportional injector



Model	euro - ref.								
	Kit A	Kit B	Kit C	Kit D	Kit E	Kit F	Kit G	Kit H	Kit I
<b>MiniDos 1%</b>	*	*	*	*	*	*	*	*	*
	IJDSMMNDKA01	IJDSMMNDKB01	IJDSMMNDKC01	IJDSMMNDKD01	IJDSMMNDKE01	IJDSMMNDKF01	IJDSMMNDKG01	IJDSMMNDKH01	IJDSMMNDKI201
<b>MiniDos 2,5%</b>	*	*	*	*	*	*	*	*	*
	IJDSMMNDKA02	IJDSMMNDKB02	IJDSMMNDKC02	IJDSMMNDKD02	IJDSMMNDKE02	IJDSMMNDKF02	IJDSMMNDKG02	IJDSMMNDKH02	IJDSMMNDKI202
<b>MiniDos 5%</b>	*	*	*	*	*	*	*	*	*
	IJDSMMNDKA05	IJDSMMNDKB05	IJDSMMNDKC05	IJDSMMNDKD05	IJDSMMNDKE05	IJDSMMNDKF05	IJDSMMNDKG05	IJDSMMNDKH05	IJDSMMNDKI205
<b>A10 10%</b>	<b>19,00</b>	<b>43,50</b>	<b>63,60</b>	<b>54,80</b>	<b>141,20</b>	-	<b>188,00</b>	<b>209,00</b>	<b>38,00</b>
	IJDSMA10KA10	IJDSMA10KB10	IJDSMA10KC10	IJDSMA10KD10	IJDSMA10KE10	IJDSMA10KF10	IJDSMA10KG10	IJDSMA10KH10	IJDSMA10KI210
<b>A12 1%</b>	<b>21,00</b>	-	<b>48,00</b>	<b>37,90</b>	<b>105,00</b>	-	<b>204,00</b>	<b>207,00</b>	<b>38,00</b>
	IJDSMA12KA01	IJDSMA12KB01	IJDSMA12KC01	IJDSMA12KD01	IJDSMA12KE01	IJDSMA12KF01	IJDSMA12KG01	IJDSMA12KH01	IJDSMA12KI201
<b>A12 2,5%</b>	<b>10,10</b>	<b>17,40</b>	<b>38,60</b>	<b>37,90</b>	<b>104,00</b>	-	<b>216,00</b>	<b>209,00</b>	<b>38,30</b>
	IJDSMA12KA02	IJDSMA12KB02	IJDSMA12KC02	IJDSMA12KD02	IJDSMA12KE02	IJDSMA12KF02	IJDSMA12KG02	IJDSMA12KH02	IJDSMA12KI202
<b>A12 5%</b>	<b>10,90</b>	<b>43,50</b>	<b>41,00</b>	<b>38,00</b>	<b>137,00</b>	-	<b>232,00</b>	<b>209,00</b>	<b>38,00</b>
	IJDSMA12KA05	IJDSMA12KB05	IJDSMA12KC05	IJDSMA12KD05	IJDSMA12KE05	IJDSMA12KF05	IJDSMA12KG05	IJDSMA12KH05	IJDSMA12KI205
<b>A30 2,5%</b>	<b>13,00</b>	<b>36,60</b>	<b>47,40</b>	<b>38,80</b>	<b>91,60</b>	<b>135,80</b>	<b>185,40</b>	<b>194,00</b>	<b>28,20</b>
	IJDSMA30KA02	IJDSMA30KB02	IJDSMA30KC02	IJDSMA30KD02	IJDSMA30KE02	IJDSMA30KF02	IJDSMA30KG02	IJDSMA30KH02	IJDSMA30KI202
<b>A30 5%</b>	<b>18,90</b>	<b>32,90</b>	<b>62,00</b>	<b>54,80</b>	<b>110,00</b>	<b>137,00</b>	<b>298,00</b>	<b>189,00</b>	<b>28,00</b>
	IJDSMA30KA05	IJDSMA30KB05	IJDSMA30KC05	IJDSMA30KD05	IJDSMA30KE05	IJDSMA30KF05	IJDSMA30KG05	IJDSMA30KH05	IJDSMA30KI205
<b>A40 2,5%</b>	<b>12,90</b>	<b>36,60</b>	<b>47,40</b>	<b>54,80</b>	<b>111,70</b>	<b>135,80</b>	<b>186,60</b>	<b>194,00</b>	<b>323,00</b>
	IJDSMA40KA02	IJDSMA40KB02	IJDSMA40KC02	IJDSMA40KD02	IJDSMA40KE02	IJDSMA40KF02	IJDSMA40KG02	IJDSMA40KH02	IJDSMA40KI202

\* on request

**SHAKER SET**<sup>TM</sup>  
FERTIGATION MIXER

FERTIGATION BENCH FOR PH AND EC SETTING



- Dosage from 2 to 4 fertilizers with set modality (preset EC value)
- Acid injection for correction
- 8 different fertigation formulas (coupled to the different zones)
- 8 independent irrigation programs, each program can manage up to 64 zones (modules of 8)
- Up to 32 daily starts for each program
- 1 emergency program controlled by external sensors (humidity and temperature probe)
- Management of 4 automatic filters back-washing by differential pressure regulator.
- Pump control or master valve
- Rain and alarm sensors (pressure, flow, etc)
- Mixers management
- Set up of pre and post washing
- Self learning system

**DOSA PRO 2**<sup>TM</sup>

PROPORTIONAL FERTIGATION UNIT



- Volume of proportional dosage of two nutritive solutions
- Set up of the amount of fertilizer per zone
- Management of acid injection (optional)
- 8 independent irrigation programs, each program can manage up to 64 zones (modules of 8)
- Up to 32 daily starts for each program
- 1 emergency program controlled by external sensors (humidity and temperature probe)
- Management of 2 automatic filters back-washing by differential pressure regulator.
- Pump control or master valve
- Rain and alarm sensors (pressure, flow, etc)

**DOSA BOX**<sup>TM</sup>

PROPORTIONAL FERTIGATION UNIT



- 2 to 4 fertilizing pipes of 500 l/h each;
- 1 acid pipe 80 lt/h
- 2/4 volumetric regulation valves
- 2/4 flowmeters and micrometric valves
- Injection pump aisi 304
- Automatic level floats
- 50 lt pre-mixing tank
- ph / ec control
- Integrated control panel
- Stainless steel frame

see "Fertigation" price list

MF2



Multifertic electric pump



Ref.	suction l/h	bar	model	€	pack	box	stock
IJMF2T10	100		3 ph	<b>1.573,00</b>	1	1	
IJMF2T20	200		3 ph	<b>1.692,00</b>	1	1	
IJMF2T30	300		3 ph	<b>1.812,00</b>	1	1	
IJMF2T50	500		3 ph	<b>2.359,00</b>	1	1	

M12



Multifertic electric pump modules



Ref.	suction l/h	model	€	pack	box	stock
IJMI2100	100	-	<b>780,00</b>	1	1	
IJMI2200	200	-	<b>900,00</b>	1	1	
IJMI2300	300	-	<b>1.020,00</b>	1	1	
IJMI2500	500	-	<b>1.582,00</b>	1	1	

A250



AISI 316 stainless steel piston metering electric pump

Ref.	h	bar	model	€	pack	box	stock
IJD101N70B11T	154	8	3 ph	<b>1.118,00</b>	1	1	
IJA175N47B19T	226	8,5	3 ph	<b>1.154,00</b>	1	1	
IJA250N54B19T	384	13	3 ph	<b>1.944,00</b>	1	1	

AGF



electric turbine agitator with flange



Ref.	L axis	HP	model	€	pack	box	stock
IJAGF08C	1000	-	cc	<b>718,00</b>	1	1	
IJAGF08M	1000	0,6	1 ph	<b>718,00</b>	1	1	
IJAGF08T	1000	0,6	3 ph	<b>636,00</b>	1	1	
IJAGF15M	1300	0,6	1 ph	<b>761,00</b>	1	1	
IJAGF15T	1300	0,6	3 ph	<b>678,00</b>	1	1	

AGP



electric turbine agitator with clamp



Ref.	L axis	HP	model	€	pack	box	stock
IJAGP08C	1000	-	cc	<b>852,00</b>	1	1	
IJAGP08M	1000	0,6	1 ph	<b>852,00</b>	1	1	
IJAGP08T	1000	0,6	3 ph	<b>758,00</b>	1	1	
IJAGP15M	1300	0,6	1 ph	<b>894,00</b>	1	1	
IJAGP15T	1300	0,6	3 ph	<b>798,00</b>	1	1	

PFF



hydraulic pump



Ref.	suction l/h	model	€	pack	box	stock
IJPEF000	250	Ecofertic	<b>815,00</b>	1	1	
IJPFF000	450	Fertic	<b>1.350,00</b>	1	1	

**CTR**

 flow meter for fertilizers  
with contact switch

Ref.	G	impulsi/lt	Q/h	€	pack	box	stock
IJCTR1320	1"	2/4	3.500	*	1	1	<input type="checkbox"/>

**GEM C**

PVC electric valve



Ref.	G	model	€	pack	box	stock
IBGEMC4011E311	½"	EPDM	<b>104,70</b>	1	1	<input type="checkbox"/>
IBGEMC4011V311	½"	VITON	<b>114,80</b>	1	1	<input type="checkbox"/>

**98127**

 pocket PH tester with watertight  
microprocessor and replaceable electrode

Ref.	model	scale	€	pack	box	stock
IJHI98127	pH51	0.0 ÷ 14,0 pH	<b>184,20</b>	1	1	<input type="checkbox"/>

**98312**

 pocket EC watertight tester  
with replaceable probe

Ref.	model	scale	€	pack	box	stock
IJHI98312	C66	0,0÷10,0 mS/cm	<b>216,40</b>	1	1	<input type="checkbox"/>

**991301**

pH / EC / TDS portable tester



Ref.	model	scale	€	pack	box	stock
IJHI991301	SM802	0.0÷14,0 pH 0,0÷6,00 mS/cm 0÷4000 ppm	<b>975,00</b>	1	1	<input type="checkbox"/>

**replacem**

replacement electrode probe for tester



Ref.	model	suitable	€	pack	box	stock
IJHI73127	HI73127	98127	<b>112,00</b>	1	1	<input type="checkbox"/>
IJHI73311	HI73311	98312	<b>112,00</b>	1	1	<input type="checkbox"/>
IJHI1288	HI1288	991301	<b>277,50</b>	1	1	<input type="checkbox"/>



calibration solutions for tester



Ref.	model	description	€	pack	box	stock
IJHI70004P	HI70004P	pH 4.01 (25 pz.x 20ml)	<b>49,90</b>	1	-	<input type="checkbox"/>
IJHI70007P	HI70007P	pH 7.01 (25 pz.x 20ml)	<b>49,90</b>	1	-	<input type="checkbox"/>
IJHI70039C	HI70039C	5.00 mS/cm (25 pz.x 20ml)	<b>60,50</b>	1	-	<input type="checkbox"/>

**TEN**

tensiometers



Ref.	H	€	pack	box	stock
ICTEN030	300	<b>215,00</b>	1	1	<input type="checkbox"/>
ICTEN060	600	<b>235,00</b>	1	1	<input type="checkbox"/>

\* on request

CP2



Commander™ PRO 2 220 VAC



Ref.	zones	fertilizers	€	pack	box	stock
ICCP2A2208	8	2	934,50	1	1	
ICCP2A2216	16	2	1.071,00	1	1	
ICCP2A2224	24	2	1.207,50	1	1	
ICCP2A2232	32	2	1.344,00	1	1	
ICCP2A2240	40	2	1.480,50	1	1	
ICCP2A2248	48	2	1.617,00	1	1	
ICCP2A2256	56	2	1.753,50	1	1	
ICCP2A2264	64	2	1.890,00	1	1	

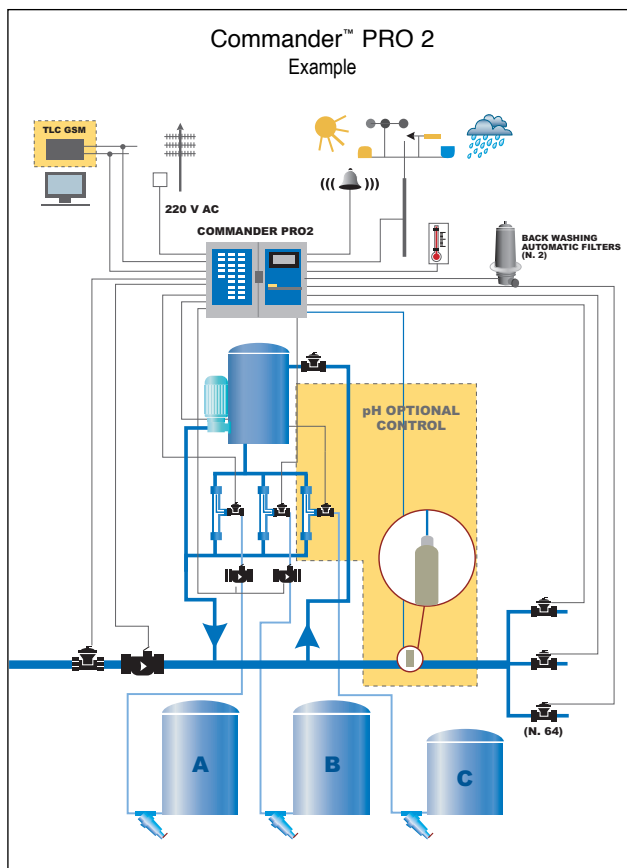

CFS



Commander™ PRO-FERTY SET 220 VAC



Ref.	zones	fertilizers	€	pack	box	stock
ICCFSA2208	8	4+1	1.827,00	1	1	
ICCFSA2216	16	4+1	1.984,50	1	1	
ICCFSA2224	24	4+1	2.142,00	1	1	
ICCFSA2232	32	4+1	2.299,50	1	1	
ICCFSA2240	40	4+1	2.614,50	1	1	
ICCFSA2248	48	4+1	2.772,00	1	1	
ICCFSA2256	56	4+1	2.929,50	1	1	

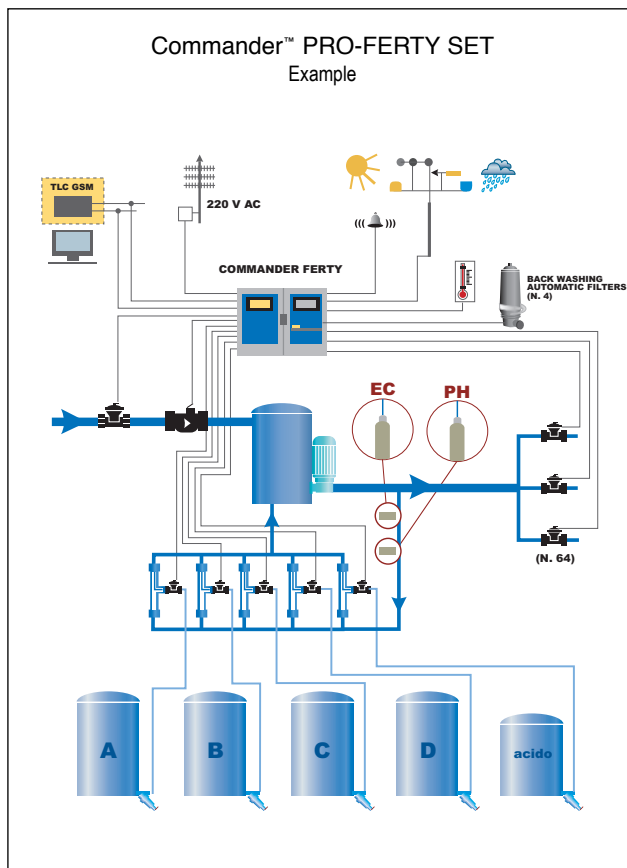

CFP



Commander™ PRO-FERTY PRO 220 VAC



Ref.	zones	fertilizers	€	pack	box	stock
ICCFPA2208	8	4+1	1.827,00	1	1	
ICCFPA2216	16	4+1	1.984,50	1	1	
ICCFPA2224	24	4+1	2.142,00	1	1	
ICCFPA2232	32	4+1	2.299,50	1	1	
ICCFPA2240	40	4+1	2.614,50	1	1	
ICCFPA2248	48	4+1	2.772,00	1	1	
ICCFPA2256	56	4+1	2.929,50	1	1	

G 75S



electric valves 24 VAC



Ref.	G	connections	flow control	€	box	stock
IBG75S301N1	3/8"	threaded F/F	no	15,00	50	<input type="checkbox"/>
IBG75S401N1	1/2"	threaded F/F	no	15,00	50	<input type="checkbox"/>
IBG75S50161	3/4"	threaded F/F	no	15,50	20	<input type="checkbox"/>
IBG75S50151	3/4"	threaded F/F	yes	15,70	20	<input type="checkbox"/>
IBG75S60161	1"	threaded F/F	no	15,50	20	<input type="checkbox"/>
IBG75S60151	1"	threaded F/F	yes	15,70	20	<input type="checkbox"/>
IBG75S70151	1" 1/2	threaded F/F	yes	50,30	6	<input type="checkbox"/>
IBG75S80151	2"	threaded F/F	yes	57,40	6	<input type="checkbox"/>

G 75S



electric valves 9 VDC latch



Ref.	G	connections	flow control	€	box	stock
IBG75S60152	1"	threaded F/F	yes	24,60	20	<input type="checkbox"/>
IBG75S70152	1" 1/2	threaded F/F	yes	58,40	6	<input type="checkbox"/>
IBG75S80152	2"	threaded F/F	yes	65,00	6	<input type="checkbox"/>

G 75C



Electronic controller with batteries  
2 stations with valve



Ref.	G	model	€	pack	box	stock
IBG75C26060	1"	2 valvole	97,90	1	9	<input type="checkbox"/>

G 75C



Electronic controller with batteries  
one station with valve



Ref.	G	connections	flow control	€	box	stock
IBG75C100	senza valvola	-	-	54,00	30	<input type="checkbox"/>
IBG75C150	3/4"	threaded F/F	no	61,30	10	<input type="checkbox"/>
IBG75C160	1"	threaded F/F	no	61,30	10	<input type="checkbox"/>
IBG75C170	1" 1/2	threaded F/F	yes	94,70	6	<input type="checkbox"/>
IBG75C180	2"	threaded F/F	yes	100,10	6	<input type="checkbox"/>

G 75C



electronic controller multistation



Ref.	model	zone	€	pack	box	stock
IBG75C81	DC latch	8	123,90	1	6	<input type="checkbox"/>
IBG75C82	AC	8	137,50	1	6	<input type="checkbox"/>

G 75C



electronic controller with batteries  
one station with valve mod. Window



Ref.	G	model	€	pack	box	stock
IBG75C260	1"	Window	55,60	1	10	<input type="checkbox"/>

G 75A



1/8" solenoid valve



Ref.	model	D	type	€	pack	box	stock
IBG75A110321	plastic	1,2	NC - 24 VAC	20,30	1	25	<input type="checkbox"/>
IBG75A110322	plastic	1,2	NC - 9-12 VDC latch	25,10	1	25	<input type="checkbox"/>
IBG75A110421	plastic	1,2	NA - 24 VAC	20,30	1	25	<input type="checkbox"/>
IBG75A110422	plastic	1,2	NA - 9-12 VDC latch	25,10	1	25	<input type="checkbox"/>
IBG75A110431	plastic	1,6	NC - 24 VAC	20,40	1	25	<input type="checkbox"/>
IBG75A310321	metal	1,2	NC - 24 VAC	35,60	1	25	<input type="checkbox"/>
IBG75A310322	metal	1,2	NC - 9-12 VDC latch	35,90	1	25	<input type="checkbox"/>
IBG75A310412	metal	1,0	NC - 9-12 VDC latch	35,90	1	25	<input type="checkbox"/>

G 75PR



pressure regulator valves



Ref.	G	connections	flow control	€	box	stock
IBG75PR7015	1" 1/2	threaded F/F	yes	145,90	2	<input type="checkbox"/>
IBG75PR8015	2"	threaded F/F	yes	159,50	3	<input type="checkbox"/>

G 75P



GALIT pilot 1/8"



Ref.	model	power supply	€	pack	box	stock
IBG75P101	plastic	24 VAC	92,00	1	-	<input type="checkbox"/>
IBG75P102	plastic	9-12 VDC latch	92,00	1	-	<input type="checkbox"/>
IBG75P104	plastic	12 VDC	92,00	1	-	<input type="checkbox"/>

G 75O



spare solenoid for Baccara  
electronic valves



Ref.	-	description	€	pack	stock
IBG75O1001	-	24 VAC	11,90	1	<input type="checkbox"/>
IBG75O1002	-	9-12 VDC latch	17,50	1	<input type="checkbox"/>
IBG75O1004	-	12 VDC	14,30	1	<input type="checkbox"/>
IBG75O1005	-	24 VDC	14,30	1	<input type="checkbox"/>

MEM



spare diaphragm for Baccara  
electric valves



Ref.	-	model	€	pack	stock
IBG75SMEM60	-	G 75S 3/4" / 1"	5,90	1	<input type="checkbox"/>
IBG75SMEM80	-	G 75S 1" 1/2 / 2"	12,60	1	<input type="checkbox"/>



VEL



cast iron hydraulic valve with electric control 24 VAC solenoid

Ref.	G - dn	connections	€	pack	box	stock
IAVEL00000250	1" ½	threaded	96,00	1	1	
IAVEL00000263	2"	threaded	96,00	1	1	
IAVEL00000275	2" ½	threaded	118,00	1	1	
IAVEL0000029A	3" A (323)	threaded	136,60	1	1	
IAVEL0000029C	3" C	threaded	172,10	1	1	
IAVEL0000019P	dn 80 P	flanged	200,00	1	1	
IAVEL00000211	4"	threaded	289,00	1	1	
IAVEL00000111	dn 100	flanged	319,00	1	1	
IAVEL00000112	dn 125	flanged	353,00	1	1	
IAVEL00000115	dn 150	flanged	698,00	1	1	

VPB



cast iron hydraulic valve with battery control

Ref.	G - dn	connections	€	pack	box	stock
IAPB00000263	2"	threaded	193,00	1	1	
IAPB00000275	2" ½	threaded	216,00	1	1	
IAPB0000029A	3" A (323)	threaded	233,00	1	1	
IAPB0000029C	3" C	threaded	270,00	1	1	
IAPB0000019P	dn 80 P	flanged	297,00	1	1	
IAPB00000211	4"	threaded	387,00	1	1	
IAPB00000111	dn 100	flanged	418,00	1	1	
IAPB00000112	dn 125	flanged	454,00	1	1	
IAPB00000115	dn 150	flanged	809,00	1	1	

VR3



cast iron pressure reducing control valve with 3 way plastic pilot

supplied with spring 1-5 bar, other settings available on request

Ref.	G - dn	connections	€	pack	box	stock
I AVR300000263	2"	threaded	167,00	1	1	
I AVR300000275	2" ½	threaded	190,00	1	1	
I AVR30000029A	3" A (323)	threaded	207,40	1	1	
I AVR30000029C	3" C	threaded	242,00	1	1	
I AVR30000019P	dn 80 P	flanged	271,00	1	1	
I AVR300000211	4"	threaded	426,00	1	1	
I AVR300000111	dn 100	flanged	450,00	1	1	
I AVR300000112	dn 125	flanged	472,00	1	1	
I AVR300000115	dn 150	flanged	780,00	1	1	

VMS



cast iron pressure reducing control valve with 3 way metal pilot

supplied with spring 1-5 bar, other settings available on request

Ref.	G - dn	connections	€	pack	box	stock
I AVM300000263	2"	threaded	223,00	1	1	
I AVM300000275	2" ½	threaded	243,00	1	1	
I AVM30000029A	3" A (323)	threaded	264,00	1	1	
I AVM30000029C	3" C	threaded	298,00	1	1	
I AVM30000019P	dn 80 P	flanged	329,00	1	1	
I AVM300000211	4"	threaded	416,00	1	1	
I AVM300000111	dn 100	flanged	447,00	1	1	
I AVM300000112	dn 125	flanged	478,00	1	1	
I AVM300000115	dn 150	flanged	834,00	1	1	

VSO



cast iron pressure sustaining control valve with 3 way metal pilot

supplied with spring 1-5 bar, other settings available on request

Ref.	G - dn	connections	€	pack	box	stock
I AVSO00000263	2"	threaded	223,00	1	1	
I AVSO00000275	2" ½	threaded	243,00	1	1	
I AVSO0000029A	3" A (323)	threaded	264,00	1	1	
I AVSO0000029C	3" C	threaded	326,00	1	1	
I AVSO0000019P	dn 80 P	flanged	352,00	1	1	
I AVSO00000211	4"	threaded	416,00	1	1	
I AVSO00000111	dn 100	flanged	447,00	1	1	
I AVSO00000112	dn 125	flanged	478,00	1	1	
I AVSO00000115	dn 150	flanged	834,00	1	1	

VSI



cast iron quick relief valve with metal pilot

Ref.	G - dn	connections	€	pack	box	stock
I AVSI00000263	2"	threaded	237,00	1	1	
I AVSI00000275	2" ½	threaded	260,00	1	1	
I AVSI0000029A	3" A (323)	threaded	277,00	1	1	
I AVSI0000029C	3" C	threaded	315,00	1	1	
I AVSI0000019P	dn 80 P	flanged	342,00	1	1	
I AVSI00000211	4"	threaded	432,00	1	1	
I AVSI00000111	dn 100	flanged	461,00	1	1	
I AVSI00000112	dn 125	flanged	494,00	1	1	
I AVSI00000115	dn 150	flanged	849,00	1	1	

PEL



Nylon hydraulic valve with electric control 24 vac solenoid

Ref.	G	connections	€	pack	box	stock
I APEL00000263	2"	threaded	75,60	1	1	
I APEL0000029A	3"	threaded	105,90	1	1	
I APEL0000029C	3"	threaded	210,60	1	1	

PR3



Nylon pressure reducing control valve with 3 way plastic pilot

supplied with spring 1-5 bar, other settings available on request

Ref.	G	connections	€	pack	box	stock
I APR300000263	2"	threaded	115,00	1	1	
I APR30000029A	3"	threaded	145,00	1	1	

**TWE**

tangential water meter



Ref.	G - dn	connections	m³/h	€	pack	box	stock
IATWE00000250	2"	threaded	15,0	<b>164,00</b>	1	1	
IATWE00000150	dn 50	flanged	15,0	<b>168,80</b>	1	1	
IATWE00000165	dn 65	flanged	25,0	<b>177,00</b>	1	1	
IATWE00000180	dn 80	flanged	40,0	<b>204,90</b>	1	1	
IATWE00000110	dn 100	flanged	60,0	<b>241,60</b>	1	1	
IATWE00000112	dn 125	flanged	100,0	<b>257,00</b>	1	1	
IATWE00000115	dn 150	flanged	150,0	<b>397,00</b>	1	1	

**EIR**

 REED contact switch  
for TWP flow meter

Ref.	€	pack	box	stock
IAEIR00000000	<b>40,90</b>	1	1	

**P3**

3 way pilot

supplied with spring 1-5 bar, other settings available on request

Ref.	model	type	€	pack	box	stock
IAP3P	plastic		<b>80,00</b>	1	1	
IAP3M	metal	reducer /	<b>137,00</b>	1	1	
IAP3P1 (S.GALIT)	plastic	pressure sustaining	<b>80,00</b>	1	1	

**MOR**

setting spring 3 way pilot

supplied with spring 1-5 bar, other settings available on request

Ref.	model	-	€	pack	box	stock
IAMOR00000215	0,2+1,5	-	<b>8,00</b>	1	-	
IAMOR00000230	0,2+3,0	-	<b>8,00</b>	1	-	
IAMOR00001090	1,0+9,0	-	<b>8,00</b>	1	-	

**MEM**

hydraulic valves diaphragm

Ref.	model	€	pack	box	stock
IAMEM00000630	2" - 2" ½ - 3" A	<b>23,70</b>	1	1	
IAMEM0000090C	3" C - dn 80 P	<b>35,50</b>	1	1	
IAMEM00000110	4" - dn 100 - dn 125	<b>67,50</b>	1	1	
IAMEM00000115	dn 150	<b>132,40</b>	1	1	

**MOL**

spring for hydraulic valves

Ref.	model	€	pack	box	stock
IAMOL00000630	2" - 2" ½ - 3" A	<b>3,60</b>	1	1	
IAMOL0000090C	3" C - dn 80 P	<b>8,20</b>	1	1	
IAMOL00000110	4" - dn 100 - dn 125	<b>29,10</b>	1	1	
IAMOL00000115	dn 150	<b>58,30</b>	1	1	



	page
Quick joints pn4 for PE pipe	44-45
Insert fittings for PE pipe	46-47
Offtakes for PE-PVC pipes	48
Layflat fittings	49
Tape fittings	50-51
Dripline fittings	52-53
Compact cylinder valves	54-55
Rabbit cylinder valves	56-57
Ball valves - Mini ball valves	58
Quick coupling valves	59
Pressure regulators - Air release valves	59
Threaded fittings	60-61
Fittings for spiral pipes	62



female threaded adaptor

801



Ref.	D x G	€	pack	box	type	stock
IE80120FON20A	20 x 3/8"	0,431	50	400	C	<input type="checkbox"/>
IE80120FON20B	20 x 1/2"	0,441	50	300	C	<input type="checkbox"/>
IE80120FON20C	20 x 3/4"	0,480	50	250	C	<input checked="" type="checkbox"/>
IE80120FOV25B	25 x 1/2"	0,507	50	200	C	<input type="checkbox"/>
IE80120FOV25C	25 x 3/4"	0,519	50	200	C	<input checked="" type="checkbox"/>
IE80120FOV25D	25 x 1"	0,563	50	150	C	<input type="checkbox"/>
IE80120FOV32C	32 x 3/4"	0,585	30	300	B	<input type="checkbox"/>
IE80120FOV32D	32 x 1"	0,645	30	240	B	<input checked="" type="checkbox"/>
IE80130FON36D	36 x 1"	0,728	-	240	B	<input type="checkbox"/>
IE80130FON40D	40 x 1"	0,761	20	240	B	<input type="checkbox"/>

coupling

810



Ref.	D x D	€	pack	box	type	stock
IE8102000N160	16 x 16	0,290	50	400	C	<input checked="" type="checkbox"/>
IE8102000N200	20 x 20	0,397	50	250	C	<input checked="" type="checkbox"/>
IE8102000V250	25 x 25	0,504	50	150	C	<input checked="" type="checkbox"/>
IE8102000V320	32 x 32	0,643	30	180	B	<input checked="" type="checkbox"/>
IE8103000N360	36 x 36	0,800	-	200	B	<input type="checkbox"/>
IE8103000N400	40 x 40	0,980	20	180	B	<input checked="" type="checkbox"/>

reducing coupling

811



Ref.	D x G	€	pack	box	type	stock
IE81120M0N16B	16 x 1/2"	0,208	50	500	C	<input checked="" type="checkbox"/>
IE81120M0N16C	16 x 3/4"	0,210	50	500	C	<input checked="" type="checkbox"/>
IE81120M0N20A	20 x 3/8"	0,278	50	500	C	<input type="checkbox"/>
IE81120M0N20B	20 x 1/2"	0,278	50	350	C	<input type="checkbox"/>
IE81120M0N20C	20 x 3/4"	0,287	50	350	C	<input checked="" type="checkbox"/>
IE81120M0N20D	20 x 1"	0,353	50	300	C	<input checked="" type="checkbox"/>
IE81120M0V25B	25 x 1/2"	0,314	50	250	C	<input type="checkbox"/>
IE81120M0V25C	25 x 3/4"	0,326	50	250	C	<input checked="" type="checkbox"/>
IE81120M0V25D	25 x 1"	0,353	50	200	C	<input checked="" type="checkbox"/>
IE81120M0V32C	32 x 3/4"	0,386	30	300	B	<input type="checkbox"/>
IE81120M0V32D	32 x 1"	0,419	30	300	B	<input checked="" type="checkbox"/>
IE81120M0V32E	32 x 1" 1/4	0,468	30	270	B	<input type="checkbox"/>
IE81130M0N36D	36 x 1"	0,556	-	350	B	<input type="checkbox"/>
IE81130M0N36E	36 x 1" 1/4	0,556	-	320	B	<input type="checkbox"/>
IE81130M0N40D	40 x 1"	0,635	20	240	B	<input checked="" type="checkbox"/>
IE81130M0N40E	40 x 1" 1/4	0,670	20	200	B	<input checked="" type="checkbox"/>

male adaptor

812



Ref.	D x D	€	pack	box	type	stock
IE8122000N20A	20 x 16	0,482	50	300	C	<input checked="" type="checkbox"/>
IE8122000V25B	25 x 20	0,612	50	200	C	<input checked="" type="checkbox"/>
IE8122000V32C	32 x 25	0,612	50	200	B	<input type="checkbox"/>
IE8123000N36D	36 x 32	0,740	-	300	B	<input type="checkbox"/>
IE8123000N40D	40 x 32	0,800	20	200	B	<input type="checkbox"/>
IE8123000N40E	40 x 36	0,870	20	200	B	<input type="checkbox"/>

swivel female threaded adaptor

813



Ref.	D	€	pack	box	type	stock
IE8132000N160	16	0,239	50	800	C	<input checked="" type="checkbox"/>
IE8132000N200	20	0,300	50	450	C	<input checked="" type="checkbox"/>
IE8132000V250	25	0,375	50	300	C	<input checked="" type="checkbox"/>
IE8132000V320	32	0,408	30	360	C	<input checked="" type="checkbox"/>
IE8133000N360	36	0,504	50	350	B	<input type="checkbox"/>
IE8133000N400	40	0,618	20	300	C	<input type="checkbox"/>

plug

802



Ref.	D x G	€	pack	box	type	stock
IE80220FON16C	16 x 3/4"	0,500	50	250	C	<input type="checkbox"/>

90° male threaded elbow

824



Ref.	D x G	€	pack	box	type	stock
IE82420M0N16B	16 x 1/2"	0,298	50	450	C	<input type="checkbox"/>
IE82420M0N16C	16 x 3/4"	0,298	50	450	C	<input type="checkbox"/>
IE82420M0N20B	20 x 1/2"	0,414	50	350	C	<input checked="" type="checkbox"/>
IE82420M0N20C	20 x 3/4"	0,414	50	300	C	<input checked="" type="checkbox"/>
IE82420M0V25C	25 x 3/4"	0,483	50	200	C	<input checked="" type="checkbox"/>
IE82420M0V32D	32 x 1"	0,675	30	300	B	<input checked="" type="checkbox"/>
IE82420M0V32E	32 x 1" 1/4	0,675	20	240	B	<input type="checkbox"/>
IE82420M0N40E	40 x 1" 1/4	1,53	10	160	B	<input type="checkbox"/>

90° elbow

823



Ref.	D x D	€	pack	box	type	stock
IE8232000N160	16 x 16	0,426	50	350	C	<input checked="" type="checkbox"/>
IE8232000N200	20 x 20	0,590	50	200	C	<input checked="" type="checkbox"/>
IE8232000V250	25 x 25	0,670	50	100	C	<input checked="" type="checkbox"/>
IE8232000V320	32 x 32	0,930	30	240	B	<input checked="" type="checkbox"/>
IE8233000N400	40 x 40	2,49	10	160	B	<input type="checkbox"/>

tee with male thread

816



Ref.	D x G x D	€	pack	box	type	stock
IE81620M0N16B	16 x 1/2" x 16	0,454	30	240	C	■
IE81620M0N16C	16 x 3/4" x 16	0,454	30	240	C	■
IE81620M0N20B	20 x 1/2" x 20	0,602	30	360	B	■
IE81620M0N20C	20 x 3/4" x 20	0,602	30	300	B	■
IE81620M0N20D	20 x 1" x 20	0,624	30	300	B	■
IE81620M0V25B	25 x 1/2" x 25	0,708	30	240	B	■
IE81620M0V25C	25 x 3/4" x 25	0,708	30	240	B	■
IE81620M0V25D	25 x 1" x 25	0,708	30	120	B	■
IE81620M0V32D	32 x 1" x 32	0,930	20	180	B	■
IE81620M0V32E	32 x 1" 1/4 x 32	0,953	20	160	B	■
IE81630M0N36D	36 x 1" x 36	1,19	-	200	B	■
IE81630M0N36E	36 x 1" 1/4 x 36	1,19	-	180	B	■
IE81630M0N40D	40 x 1" x 40	1,30	10	100	B	■
IE81630M0N40E	40 x 1" 1/4 x 40	1,30	10	100	B	■

tee female thread

815



Ref.	D x G x D	€	pack	box	type	stock
IE81530F0N32C	32 x 3/4" x 32	1,10	20	180	B	■
IE81530F0N32D	32 x 1" x 32	1,11	20	160	B	■

Y fitting

821



Ref.	G x D x D	€	pack	box	type	stock
IE82130M0N25C	3/4" x 25 x 25	1,07	30	210	B	■
IE82130M0N32C	1" x 25 x 25	1,46	20	80	C	■
IE82130M0N32D	1" x 32 x 32	1,30	20	120	B	■
IE82130M0N40C	1" 1/4 x 25 x 25	1,36	20	140	B	■
IE82130M0N40D	1" 1/4 x 32 x 32	1,56	10	120	B	■
IE82130M0N40E	1" 1/4 x 40 x 40	1,66	10	80	B	■
IE82130M0N50D	1" 1/2 x 32 x 32	1,38	10	100	B	■
IE82130M0N50E	1" 1/2 x 40 x 40	1,70	10	80	B	■
IE82130M0N63D	2" x 32 x 32	1,63	10	100	B	■
IE82130M0N63E	2" x 40 x 40	1,72	10	80	B	■

90° tee

814



Ref.	D x D x D	€	pack	box	type	stock
IE8142000N160	16 x 16 x 16	0,516	30	210	C	■
IE8142000N20A	20 x 16 x 20	0,658	30	120	C	■
IE8142000N200	20 x 20 x 20	0,771	30	120	C	■
IE8142000N20C	20 x 25 x 20	0,771	30	210	B	■
IE8142000V250	25 x 25 x 25	0,900	30	180	B	■
IE8142000V25D	25 x 32 x 25	0,822	30	210	B	■
IE8142000V320	32 x 32 x 32	1,20	20	140	B	■
IE8142000V32E	32 x 40 x 32	2,51	20	120	B	■
IE8143000N360	36 x 36 x 36	1,35	-	100	B	■
IE8143000N36E	36 x 40 x 36	1,35	-	130	B	■
IE8143000N400	40 x 40 x 40	1,63	-	80	B	■

tee with male thread

820



Ref.	D x D x G	€	pack	box	type	stock
IE82030M0N25C	25 x 25 x 3/4"	0,738	30	330	B	■
IE82030M0N25D	25 x 25 x 1"	0,738	30	240	B	■
IE82030M0N32D	32 x 32 x 1"	0,998	20	240	B	■
IE82030M0N32E	32 x 32 x 1" 1/4	0,998	20	140	B	■
IE82030M0N36D	36 x 36 x 1"	1,20	1	140	-	■
IE82030M0N40D	40 x 40 x 1"	1,33	10	110	B	■
IE82030M0N40E	40 x 40 x 1" 1/4	1,33	10	110	B	■

Y fitting

822



Ref.	G x G x G	€	pack	box	type	stock
IE82230M0N25B	3/4" x 1/2" x 1/2"	0,715	30	360	B	■
IE82230M0N25C	3/4" x 3/4" x 3/4"	0,715	30	360	B	■
IE82230M0N32B	1" x 1/2" x 1/2"	0,867	20	360	B	■
IE82230M0N32C	1" x 3/4" x 3/4"	0,867	20	360	B	■
IE82230M0N32D	1" x 1" x 1"	0,987	20	240	B	■
IE82230M0N40C	1" 1/4 x 3/4" x 3/4"	0,987	10	240	B	■
IE82230M0N40D	1" 1/4 x 1" x 1"	0,987	10	180	B	■
IE82230M0N40E	1" 1/4 x 1" 1/4 x 1" 1/4	0,987	10	120	B	■
IE82230M0N50D	1" 1/2 x 1" x 1"	1,01	10	140	B	■
IE82230M0N50E	1" 1/2 x 1" 1/4 x 1" 1/4	1,01	10	140	B	■
IE82230M0N63D	2" x 1" x 1"	1,18	10	120	B	■
IE82230M0N63E	2" x 1" 1/4 x 1" 1/4	1,18	10	100	B	■

light male adaptor



Ref.	D x G	€	pack	box	type	stock
IP30250M0N16C	16 x 3/4"	0,057	-	1000	C	<input type="checkbox"/>
IP30250M0N20C	20 x 3/4"	0,060	-	800	C	<input type="checkbox"/>



light coupling



Ref.	D x D	€	pack	box	type	stock
IP3042000N160	16 x 16	0,037	-	1500	C	<input type="checkbox"/>
IP3042000N200	20 x 20	0,039	-	1000	C	<input type="checkbox"/>



male adaptor



Ref.	D x G	€	pack	box	type	stock
IP60250M0N16B	16 x 1/2"	0,119	100	2000	B	<input type="checkbox"/>
IP60250M0N16C	16 x 3/4"	0,125	100	1400	B	<input type="checkbox"/>
IP60250M0N20B	20 x 1/2"	0,122	100	1800	B	<input type="checkbox"/>
IP60250M0N20C	20 x 3/4"	0,129	100	1200	B	<input type="checkbox"/>
IP60220M0N25B	25 x 1/2"	0,146	100	1000	B	<input type="checkbox"/>
IP60220M0N25C	25 x 3/4"	0,151	100	1000	B	<input type="checkbox"/>
IP60220M0N25D	25 x 1"	0,164	50	600	B	<input type="checkbox"/>
IP60220M0N32C	32 x 3/4"	0,156	50	500	B	<input type="checkbox"/>
IP60220M0N32D	32 x 1"	0,156	50	400	B	<input type="checkbox"/>
IP60220M0N32E	32 x 1 1/4"	0,210	50	300	B	<input type="checkbox"/>
IP60220M0N36D	36 x 1"	0,210	-	500	B	<input type="checkbox"/>
IP60220M0N36E	36 x 1 1/4"	0,232	-	400	B	<input type="checkbox"/>
IP60220M0N40D	40 x 1"	0,255	25	300	B	<input type="checkbox"/>
IP60220M0N40E	40 x 1 1/4"	0,323	25	250	B	<input type="checkbox"/>
IP60220M0N50F	50 x 1 1/2"	0,380	25	200	B	<input type="checkbox"/>
IP60220M0N63G	63 x 2"	1,01	-	100	B	<input type="checkbox"/>
IP60220M0N75H	75 x 2 1/2"	2,57	-	60	B	<input type="checkbox"/>
IP60220M0N90I	90 x 3"	2,89	-	40	B	<input type="checkbox"/>



coupling



Ref.	D x D	€	pack	box	type	stock
IP6042000N160	16 x 16	0,065	100	2400	B	<input type="checkbox"/>
IP6045000N200	20 x 20	0,085	100	1600	B	<input type="checkbox"/>
IP6042000N250	25 x 25	0,121	50	800	B	<input type="checkbox"/>
IP6042000N320	32 x 32	0,155	50	500	B	<input type="checkbox"/>
IP6042000N360	36 x 36	0,204	-	450	B	<input type="checkbox"/>
IP6042000N400	40 x 40	0,300	25	300	B	<input type="checkbox"/>
IP6042000N500	50 x 50	0,430	-	190	B	<input type="checkbox"/>
IP6042000N630	63 x 63	0,800	-	100	B	<input type="checkbox"/>
IP6042000N750	75 x 75	2,57	-	60	B	<input type="checkbox"/>
IP6042000N900	90 x 90	2,90	-	40	B	<input type="checkbox"/>



Ref.	D x D x D	€	pack	box	type	stock
IP6062000N160	16 x 16 x 16	0,066	100	2000	B	<input type="checkbox"/>
IP6062000N200	20 x 20 x 20	0,088	100	1000	B	<input type="checkbox"/>
IP6065000N250	25 x 25 x 25	0,244	50	400	B	<input type="checkbox"/>
IP6065000N320	32 x 32 x 32	0,465	25	250	B	<input type="checkbox"/>
IP6065000N400	40 x 40 x 40	0,690	10	120	B	<input type="checkbox"/>
IP6062000N750	75 x 75 x 75	3,86	-	34	B	<input type="checkbox"/>
IP6062000N900	90 x 90 x 90	4,49	-	18	B	<input type="checkbox"/>



tee



Ref.	D x G x D	€	pack	box	type	stock
IP60820M0N16B	16 x 1/2" x 16	0,113	100	1400	B	<input type="checkbox"/>
IP60820M0N16C	16 x 3/4" x 16	0,125	100	1200	B	<input type="checkbox"/>
IP60820M0N20B	20 x 1/2" x 20	0,190	100	900	B	<input type="checkbox"/>
IP60820M0N20C	20 x 3/4" x 20	0,197	100	800	B	<input type="checkbox"/>
IP60850M0N25B	25 x 1/2" x 25	0,329	50	600	B	<input type="checkbox"/>
IP60850M0N25C	25 x 3/4" x 25	0,339	50	500	B	<input type="checkbox"/>
IP60850M0N25D	25 x 1" x 25	0,339	50	400	B	<input type="checkbox"/>
IP60850M0N32D	32 x 1" x 32	0,465	25	250	B	<input type="checkbox"/>
IP60850M0N32E	32 x 1 1/4" x 32	0,521	25	200	B	<input type="checkbox"/>
IP60850M0N40D	40 x 1" x 40	0,679	10	160	B	<input type="checkbox"/>
IP60850M0N40E	40 x 1 1/4" x 40	0,679	10	160	B	<input type="checkbox"/>



tee with male thread



Ref.	D	€	pack	box	type	stock
IP6002000N160	16	0,024	500	5000	C	<input type="checkbox"/>
IP6003000N200	20	0,068	200	1600	B	<input type="checkbox"/>
IP6003000N250	25	0,171	50	500	C	<input type="checkbox"/>
IP6003000N320	32	0,187	50	350	C	<input type="checkbox"/>



plug

insert fitting with nut



Ref.	D x G	€	pack	box	type	stock
IP64860F0N05B	5 x 1/2"	0,171	100	1600	C	<input type="checkbox"/>
IP64860F0N09B	9 x 1/2"	0,181	1	3000	B	<input type="checkbox"/>
IP64820F0N16B	16 x 1/2"	0,210	100	1300	B	<input type="checkbox"/>
IP64820F0N16C	16 x 3/4"	0,221	100	1200	B	<input type="checkbox"/>
IP64820F0N20C	20 x 3/4"	0,295	100	1000	B	<input type="checkbox"/>
IP64820F0N25D	25 x 1"	0,340	50	400	B	<input type="checkbox"/>
IP64820F0N25E	25 x 1 1/4"	0,397	50	300	B	<input type="checkbox"/>
IP64820F0N32E	32 x 1 1/4"	0,534	50	350	B	<input type="checkbox"/>
IP64820F0N40F	40 x 1 1/2"	0,635	50	200	B	<input type="checkbox"/>



Ref.	D x D	€	pack	box	type	stock
IP6035000N20A	20 x 16	0,080	100	2000	B	<input type="checkbox"/>
IP6035000N25A	25 x 16	0,150	100	1000	B	<input type="checkbox"/>
IP6035000N25B	25 x 20	0,157	100	1000	B	<input type="checkbox"/>
IP6032000N32C	32 x 25	0,176	50	500	B	<input type="checkbox"/>
IP6032000N40D	40 x 32	0,270	50	350	B	<input type="checkbox"/>



reducing coupling

616



reducing tee



Ref.	D x D x D	€	pack	box	type	stock
IP6163000N164	16 x 4 x 16	<b>0,149</b>	100	2400	B	
IP6162000N16B	16 x 20 x 16	<b>0,103</b>	100	1600	B	
IP6165000N20A	20 x 16 x 20	<b>0,237</b>	100	1000	B	
IP6165000N20C	20 x 25 x 20	<b>0,315</b>	100	600	B	
IP6165000N25A	25 x 16 x 25	<b>0,346</b>	50	500	B	
IP6165000N25B	25 x 20 x 25	<b>0,368</b>	50	500	B	
IP6165000N25D	25 x 32 x 25	<b>0,403</b>	50	400	B	
IP6165000N32E	32 x 40 x 32	<b>0,562</b>	25	200	B	

641



90° elbow with male thread



Ref.	D x G	€	pack	box	type	stock
IP64150M0N16B	16 x 1/2"	<b>0,125</b>	100	2000	B	
IP64150M0N16C	16 x 3/4"	<b>0,131</b>	100	1500	B	
IP64150M0N20B	20 x 1/2"	<b>0,136</b>	100	1600	B	
IP64150M0N20C	20 x 3/4"	<b>0,141</b>	100	1200	B	
IP64150M0N25C	25 x 3/4"	<b>0,375</b>	50	800	B	
IP64150M0N25D	25 x 1"	<b>0,375</b>	100	600	B	
IP64150M0N32D	32 x 1"	<b>0,431</b>	50	400	B	
IP64150M0N32E	32 x 1 1/4"	<b>0,511</b>	50	300	B	
IP64120M0N40D	40 x 1"	<b>1,12</b>	25	200	B	
IP64120M0N40E	40 x 1 1/4"	<b>1,12</b>	25	200	B	

640



90° elbow



Ref.	D x D	€	pack	box	type	stock
IP6405000N160	16 x 16	<b>0,091</b>	100	2500	B	
IP6405000N200	20 x 20	<b>0,108</b>	100	1600	B	
IP6405000N250	25 x 25	<b>0,340</b>	100	600	B	
IP6405000N320	32 x 32	<b>0,408</b>	50	400	B	
IP6402000N400	40 x 40	<b>0,851</b>	25	200	B	
IP6402000N750	75 x 75	<b>3,52</b>	-	48	B	
IP6402000N900	90 x 90	<b>4,14</b>	-	24	B	

642



90° reducing elbow



Ref.	D x D	€	pack	box	type	stock
IP6425000N20A	20 x 16	<b>0,318</b>	100	1800	B	

618



tee with male thread



Ref.	D x D x G	€	pack	box	type	stock
IP6185000N25C	25 x 25 x 3/4"	<b>0,335</b>	50	500	B	
IP6185000N25D	25 x 25 x 1"	<b>0,368</b>	50	400	B	
IP6185000N32D	32 x 32 x 1"	<b>0,431</b>	25	200	B	
IP6185000N32E	32 x 32 x 1 1/4"	<b>0,488</b>	25	200	B	
IP6185000N40E	40 x 40 x 1 1/4"	<b>0,602</b>	10	100	B	

645



inspectable end plug



Ref.	D	€	pack	box	type	stock
IP6452000N750	75	<b>4,01</b>	1	45	B	
IP6452000N900	90	<b>4,66</b>	1	36	B	

650



Y fitting



Ref.	G x D x D	€	pack	box	type	stock
IP6502000N16C	3/4" x 16 x 16	<b>0,556</b>	100	400	C	
IP6505000N25C	3/4" x 25 x 25	<b>0,602</b>	25	300	B	
IP6505000N32C	1" x 25 x 25	<b>0,624</b>	30	240	B	
IP6505000N32D	1" x 32 x 32	<b>0,794</b>	20	160	B	
IP6505000N40D	1 1/4" x 32 x 32	<b>0,794</b>	20	140	B	

643



cross



Ref.	D x D x D x D	€	pack	box	type	stock
IP6432000N750	75 x 75 x 75 x 75	<b>6,41</b>	-	10	B	
IP6432000N900	90 x 90 x 90 x 90	<b>7,07</b>	-	10	B	

651



3 way fitting



Ref.	G x D x D x D	€	pack	box	type	stock
IP65123M0N16C	3/4" x 16 x 16 x 16	<b>0,612</b>	100	300	C	

DCU



**offtake with rubber for PE pipe**  
assembly requires 12 mm hole made with item FUS - FUT - PNZ  
To be used with ø 32mm and higher



Ref.	D	€	pack	box	type	stock
IIDCU2000N160	16	0,060	500	3000	B	<input checked="" type="checkbox"/>
IIDCU2000N200	20	0,071	500	2500	B	<input checked="" type="checkbox"/>

DSU



**offtake without rubber for PE pipe**  
assembly requires 12 mm hole made with item FUS - FUT - PNZ  
To be used with ø 32mm and higher



Ref.	D	€	pack	box	type	stock
IIDSU5000N160	16	0,058	500	3500	B	<input type="checkbox"/>
IIDSU5000N200	20	0,064	500	3000	B	<input type="checkbox"/>

DRU



**offtake with rubber for PE - PVC pipe**  
assembly requires 17 mm hole  
To be used with ø 32mm and higher



Ref.	D	€	pack	box	type	stock
IIDRU2000N160	16	0,157	500	2000	B	<input checked="" type="checkbox"/>
IIDRU2000N200	20	0,160	500	1500	B	<input checked="" type="checkbox"/>
0EGOP00000170	rubber	0,135	500	6000	B	<input checked="" type="checkbox"/>

DGU



**offtake with rubber for PE - PVC pipe**  
assembly requires 17 mm hole  
To be used with ø 32mm and higher



Ref.	D	€	pack	box	type	stock
IIDGU2000N160	16	0,125	500	2000	B	<input checked="" type="checkbox"/>
IIDGU2000N200	20	0,136	500	1500	B	<input type="checkbox"/>
0EGDR8000N000	rubber	0,075	500	7000	B	<input type="checkbox"/>

611



**tee offtake with rubber for PE pipe**  
assembly requires 12 mm hole made with item FUS - FUT - PNZ  
To be used with ø 32mm and higher



Ref.	D x inn x D	€	pack	box	type	stock
IP6112000N160	16 x inn x 16	0,148	100	1600	B	<input type="checkbox"/>

613



**tee offtake with rubber for PE - Pvc pipe**  
assembly requires 17 mm hole  
To be used with ø 32mm and higher



Ref.	D x inn x D	€	pack	box	type	stock
IP6132000N160	16 x inn x 16	0,227	500	1500	B	<input type="checkbox"/>

501



mini clamp saddle



Ref.	bulloni	D x D	€	pack	box	type	stock
IS5013000N32A	2	32 x 16	0,691	50	250	C	<input checked="" type="checkbox"/>
IS5013000N32B	2	32 x 20	0,740	50	250	C	<input type="checkbox"/>

OLV



**offtake with rubber with male thread for PE pipe**  
assembly requires 12 mm hole made with item FUS - FUT - PNZ  
To be used with ø 32mm and higher



Ref.	D	€	pack	box	type	stock
IIOLV20M0N250	¾"	0,134	250	2000	B	<input checked="" type="checkbox"/>
IIOLV20M0N320	1"	0,193	100	1200	B	<input type="checkbox"/>

TCU



plug for offtake  
with rubber (mod. DCU)



Ref.	D	€	pack	box	type	stock
IITCU3000N000	13 mm	0,076	500	5000	C	<input checked="" type="checkbox"/>
IITCU3000N0XL	18 mm	0,217	500	5000	C	<input type="checkbox"/>

TRU



plug for offtake  
with rubber (mod. DRU)



Ref.	D	€	pack	box	type	stock
IITRU2000N000	-	0,035	500	2500	C	<input type="checkbox"/>

DLF



threaded offtake for layflat  
assembly requires 14 mm hole with item FOR



Ref.	G	€	pack	box	type	stock
IIDLDF20D0N25B	M/F ¾" x ½"	0,210	50	1000	B	<input checked="" type="checkbox"/>
IIDLDF50M0N200	M ½"	0,210	50	1000	B	<input type="checkbox"/>
IIDLDF20F0N250	F ¾"	0,300	50	1000	B	<input checked="" type="checkbox"/>

DCF



threaded offtake for layflat  
assembly requires 14 mm hole with item FOR



Ref.	G	€	pack	box	type	stock
IIDCF20D0N25B	M/F ¾" x ½"	0,210	50	1000	B	<input type="checkbox"/>
IIDCF50M0N200	M ½"	0,210	50	1000	B	<input type="checkbox"/>
IIDCF20F0N250	F ¾"	0,300	50	1000	B	<input checked="" type="checkbox"/>

TLF



plug for layflat offtake  
assembly requires 14 mm hole with item FOR



Ref.	D	€	pack	box	type	stock
IITLF20D0N200	-	0,295	50	700	C	<input checked="" type="checkbox"/>



male adaptor for layflat



Ref.	D x G	€	pack	box	type	stock
• IP78220M0A52G	52 x 2"	1,38	1	120	B	<input type="checkbox"/>
IP78220M0A65H	65 x 2" ½	2,37	1	80	B	<input type="checkbox"/>
• IP78220M0A77I	77 x 3"	3,31	1	40	B	<input type="checkbox"/>
• IP78220M0A10L	104 x 4"	4,05	1	24	B	<input type="checkbox"/>
IP78220M0A12L	127 x 4"	6,50	1	18	B	<input type="checkbox"/>

swivel plug for layflat



Ref.	D	€	pack	box	type	stock
IP7712000A520	52	4,20	1	90	B	<input type="checkbox"/>
IP7712000A650	65	6,50	1	45	B	<input type="checkbox"/>
IP7712000A770	77	7,90	1	36	B	<input type="checkbox"/>
IP7712000A104	104	11,20	1	12	B	<input type="checkbox"/>

swivel coupling for layflat



Ref.	D x D	€	pack	box	type	stock
IP7742000A520	52 x 52	8,05	1	30	B	<input type="checkbox"/>
IP7742000A650	65 x 65	12,20	1	20	B	<input type="checkbox"/>
IP7742000A770	77 x 77	14,40	1	15	B	<input type="checkbox"/>
IP7742000A104	104 x 104	20,30	1	6	B	<input type="checkbox"/>

swivel tee for layflat



Ref.	D x D x D	€	pack	box	type	stock
IP7762000A520	52 x 52 x 52	13,30	1	14	B	<input type="checkbox"/>
IP7762000A650	65 x 65 x 65	19,70	1	6	B	<input type="checkbox"/>
IP7762000A770	77 x 77 x 77	22,80	1	5	B	<input type="checkbox"/>
IP7762000A104	104 x 104 x 104	32,00	1	2	B	<input type="checkbox"/>

clamp for layflat fittings



Ref.	D x D	€	pack	box	type	stock
H1400C0052057	52+57	2,90	1	100	-	<input type="checkbox"/>
H1400C0067073	67+73	3,95	1	50	-	<input type="checkbox"/>
H1400C0073079	73+79	4,00	1	50	-	<input type="checkbox"/>
H1400C0095105	95+105	4,45	1	50	-	<input type="checkbox"/>
H1400C0123138	123+138	5,80	1	50	-	<input type="checkbox"/>
H1400C0148162	148+162	6,50	1	25	-	<input type="checkbox"/>

• NPT thread available

coupling for layflat



Ref.	D x D	€	pack	box	type	stock
IP7842000A520	52 x 52	1,49	1	100	B	<input type="checkbox"/>
IP7842000A650	65 x 65	2,43	1	60	B	<input type="checkbox"/>
IP7842000A770	77 x 77	3,42	1	40	B	<input type="checkbox"/>
IP7842000A104	104 x 104	4,08	1	18	B	<input type="checkbox"/>
IP7842000A127	127 x 127	7,20	1	12	B	<input type="checkbox"/>
IP7842000A153	153 x 153	78,00	1	-	-	<input type="checkbox"/>

swivel adaptor for layflat



Ref.	D x G	€	pack	box	type	stock
IP77020F0A52G	52 x 2"	3,60	1	120	B	<input type="checkbox"/>
IP77020F0A65H	65 x 2" ½	5,40	1	60	B	<input type="checkbox"/>
• IP77020F0A77I	77 x 3"	6,10	1	40	B	<input type="checkbox"/>
IP77020F0A10L	104 x 4"	8,25	1	20	B	<input type="checkbox"/>

swivel adaptor male thread for layflat



Ref.	D x G	€	pack	box	type	stock
IP77220M0A52G	52 x 2"	4,30	1	72	B	<input type="checkbox"/>
IP77220M0A65H	65 x 2" ½	6,65	1	36	B	<input type="checkbox"/>
IP77220M0A77I	77 x 3"	8,10	1	20	B	<input type="checkbox"/>
IP77220M0A10L	104 x 4"	11,80	1	12	B	<input type="checkbox"/>

Swivel tee male thread for Layflat



Ref.	D x G x D	€	pack	box	type	stock
IP77820M0A52G	52 x 2" x 52	9,50	1	20	B	<input type="checkbox"/>
IP77820M0A65H	65 x 2" ½ x 65	14,20	1	10	B	<input type="checkbox"/>
IP77820M0A77I	77 x 3" x 77	16,40	1	8	B	<input type="checkbox"/>
IP77820M0A10L	104 x 4" x 104	23,30	1	3	B	<input type="checkbox"/>

For Layflat pipes look up  
price list Siplast™  
"Microirrigation 2011"

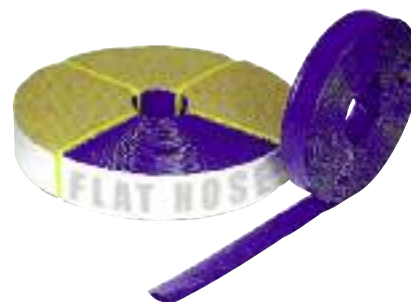

coupling for tape

850



Ref.	D x D	€	pack	box	type	stock
IE8505000N00S	TAPE 9,5	<b>0,261</b>	100	900	C	<input type="checkbox"/>
IE8505000N00T	TAPE 16	<b>0,175</b>	100	800	B	<input type="checkbox"/>
IE8505000N00U	TAPE 22	<b>0,415</b>	50	400	B	<input type="checkbox"/>
IE8505000N00P	TAPE 25	<b>0,700</b>	50	300	B	<input type="checkbox"/>
IE8505000N00V	TAPE 29	<b>1,200</b>	25	200	B	<input type="checkbox"/>

adaptor poly-tape

851



Ref.	D x D	€	pack	box	type	stock
IE8515000N16S	POLY 16 x TAPE 9,5	<b>0,185</b>	100	1000	C	<input type="checkbox"/>
IE8515000N16T	POLY 16 x TAPE 16	<b>0,149</b>	100	1000	B	<input type="checkbox"/>
IE8515000N16U	POLY 16 x TAPE 22	<b>0,360</b>	50	700	B	<input type="checkbox"/>
IE8515000N20T	POLY 20 x TAPE 16	<b>0,180</b>	100	1000	B	<input type="checkbox"/>
IE8515000N20U	POLY 20 x TAPE 22	<b>0,280</b>	50	700	B	<input type="checkbox"/>
IE8515000N20V	POLY 20 x TAPE 29	<b>0,700</b>	50	300	B	<input type="checkbox"/>

male adaptor

852



Ref.	D x G	€	pack	box	type	stock
IE85250M0N20S	TAPE 9,5 x 1/2"	<b>0,235</b>	100	1000	C	<input type="checkbox"/>
• IE85250M0N20T	TAPE 16 x 1/2"	<b>0,180</b>	100	1000	B	<input type="checkbox"/>
• IE85250M0N25T	TAPE 16 x 3/4"	<b>0,185</b>	100	1000	B	<input type="checkbox"/>
• IE85250M0N25U	TAPE 22 x 3/4"	<b>0,260</b>	50	700	B	<input type="checkbox"/>
IE85250M0N25P	TAPE 25 x 3/4"	<b>0,500</b>	50	500	B	<input type="checkbox"/>
IE85250M0N25V	TAPE 29 x 3/4"	<b>0,900</b>	25	350	B	<input type="checkbox"/>

tape fitting with nut

861



Ref.	D x G	€	pack	box	type	stock
IE86150F0N0TB	TAPE 16 x 1/2"	<b>0,380</b>	100	300	C	<input type="checkbox"/>
IE86150F0N0TC	TAPE 16 x 3/4"	<b>0,430</b>	100	700	B	<input type="checkbox"/>
IE86150F0N0UC	TAPE 22 x 3/4"	<b>0,540</b>	50	500	B	<input type="checkbox"/>

offtake with rubber

assembly requires hole: OOS/OOT/OOU = 12 mm s.r. XLU = 18 mm

853



Ref.	D	€	pack	box	type	stock
IE8535000N00S	TAPE 9.5	<b>0,197</b>	100	1200	C	<input type="checkbox"/>
IE8535000N00T	TAPE 16	<b>0,158</b>	100	1400	B	<input type="checkbox"/>
IE8535000N00U	TAPE 22	<b>0,350</b>	50	750	B	<input type="checkbox"/>
IE8535000NXLU	(XL) TAPE 22	<b>0,470</b>	50	700	B	<input type="checkbox"/>

offtake without rubber

assembly requires hole 12 mm with item FUS s.r. FUT s.r. PNZ

854



Ref.	D	€	pack	box	type	stock
IE8545000N00T	TAPE 16	<b>0,141</b>	100	1400	B	<input type="checkbox"/>

offtake with rubber

assembly requires hole: OOT = 17 mm s.r. OOU = 19 mm

863



Ref.	D	€	pack	box	type	stock
IE8635000N00T	TAPE 16	<b>0,245</b>	100	1000	B	<input type="checkbox"/>
IE8635000N00U	TAPE 22	<b>0,424</b>	50	500	B	<input type="checkbox"/>
0EGOP00000170	spare rubber 16	<b>0,125</b>	500	6000	B	<input type="checkbox"/>
0EGOP00000190	spare rubber 22	<b>0,131</b>	500	4500	B	<input type="checkbox"/>

offtake with rubber

assembly requires 15 mm hole

855



Ref.	D	€	pack	box	type	stock
IE8555000N00S	TAPE 9.5	<b>0,403</b>	100	500	C	<input type="checkbox"/>
IE8555000N00T	TAPE 16	<b>0,314</b>	100	800	C	<input type="checkbox"/>
0EGOP00000000	spare rubber	<b>0,080</b>	1	7000	C	<input type="checkbox"/>

two step offtake for layflat

assembly requires 14 mm hole with item FOR

856



Ref.	D	€	pack	box	type	stock
IE8565000N00T	TAPE 16	<b>0,403</b>	100	700	B	<input type="checkbox"/>

offtake with rubber

assembly requires 17 mm hole

864



Ref.	D	€	pack	box	type	stock
IE8645000N00T	TAPE 16	<b>0,245</b>	100	1000	B	<input type="checkbox"/>
0EGDR8000N000	spare rubber	<b>0,075</b>	500	7000	C	<input type="checkbox"/>

one step offtake for layflat

assembly requires 14 mm hole with item FOR for model Large 20 mm hole with item FOR

866



Ref.	D	€	pack	box	type	stock
IE8665000N00T	TAPE 16	<b>0,247</b>	100	700	B	<input type="checkbox"/>
IE8665000N00U	TAPE 22	<b>0,480</b>	50	700	B	<input type="checkbox"/>
IE8665000N0LU	TAPE 22 large	<b>0,450</b>	50	700	B	<input type="checkbox"/>
IE8665000N29V	TAPE 29 large	<b>0,900</b>	25	300	B	<input type="checkbox"/>

one step offtake for layflat

assembly requires 14 mm hole with item FOR

869



Ref.	D	€	pack	box	type	stock
IE8695000N00T	TAPE 16	<b>0,261</b>	100	700	B	<input type="checkbox"/>
IE8695000N00U	TAPE 22	<b>0,490</b>	50	500	B	<input type="checkbox"/>

• NPT thread available

868  reducing coupling

**irritec**

Ref.	D x D	€	pack	box	type	stock
IE8685000N0TU	TAPE 16 x TAPE 22	0,400	100	1000	C	<input type="checkbox"/>

857  tee

**irritec**

Ref.	D x D x D	€	pack	box	type	stock
IE8575000N00T	TAPE 16 x 16 x 16	0,453	50	400	B	<input type="checkbox"/>

859  90° tee with rubber  
assembly requires 15 mm hole

**irritec**

Ref.	D x inn x D	€	pack	box	type	stock
IE8595000N00T	TAPE 16 x inn. x 16	0,572	50	200	C	<input type="checkbox"/>
0EG0P00000000	spare rubber	0,080	500	7000	C	<input type="checkbox"/>

858  90° elbow

**irritec**

Ref.	D x D	€	pack	box	type	stock
IE8585000N00T	TAPE 16 x 16	0,363	100	300	C	<input type="checkbox"/>

867  tee male threaded

**irritec**

Ref.	D x G x D	€	pack	box	type	stock
IE86750M0N25T	TAPE 16 x 3/4" x 16	0,482	50	400	B	<input type="checkbox"/>

860  90° elbow with rubber  
assembly requires 15 mm hole

**irritec**

Ref.	D	€	pack	box	type	stock
IE8605000N00T	TAPE 16 x inn.	0,471	50	300	B	<input type="checkbox"/>
0EG0P00000000	spare rubber	0,080	500	7000	C	<input type="checkbox"/>

862  elbow adaptor tape/pe pipe

**irritec**

Ref.	D x D	€	pack	box	type	stock
IE8625000N16T	POLY 16 x TAPE 16	0,335	100	500	B	<input type="checkbox"/>
IE8625000N20T	POLY 20 x TAPE 16	0,372	50	500	B	<input type="checkbox"/>
IE8625000N20U	POLY 20 x TAPE 22	0,481	50	600	B	<input type="checkbox"/>

883  “easy block” offtake with rubber  
assembly requires hole: OOT/OOU = 12 mm - XLU = 18 mm

**irritec**

Ref.	D	€	pack	box	type	stock
IE8832000N00T	TAPE 16	0,120	100	2400	B	<input type="checkbox"/>
IE8832000N00U	TAPE 22	0,260	100	1600	B	<input type="checkbox"/>
IE8832000NXLU	(XL) TAPE 22	0,320	100	1400	B	<input type="checkbox"/>

880  “easy block” coupling

**irritec**

Ref.	D x D	€	pack	box	type	stock
IE8802000N00T	TAPE 16	0,140	100	1800	B	<input type="checkbox"/>
IE8802000N00U	TAPE 22	0,310	100	1000	B	<input type="checkbox"/>

881  “easy block” plug

**irritec**

Ref.	D	€	pack	box	type	stock
IE8812000N00T	TAPE 16	0,100	100	1200	C	<input type="checkbox"/>
IE8812000N00U	TAPE 22	0,180	50	800	C	<input type="checkbox"/>

886  “easy block” one step offtake for layflat  
assembly requires 14 mm hole with item FOR

**irritec**

Ref.	D	€	pack	box	type	stock
IE8865000N00U	TAPE 22	0,480	50	700	B	<input type="checkbox"/>

For Tape and Light Dripline  
look up Siplast™  
“Microirrigation 2011” price list

**P1™ 16 mm**

**P1™ Ultra 22 mm**

**P1™ Maxi 25 mm**

**P1™ Extra 29 mm**

**isiplast TAPE 16 mm**

**isiplast TAPE 22 mm**



coupling

830



Ref.	D x D	€	pack	box	type	stock
IE8306000N160	16 x 16	0,053	100	4200	B	<input type="checkbox"/>
IE8306000M170	17 x 17 *	0,055	100	3600	B	<input type="checkbox"/>
IE8306000N200	20 x 20	0,076	100	2000	B	<input type="checkbox"/>

offtake with rubber

assembly requires 12 mm hole with item FUS - FUT - PNZ

833



Ref.	D	€	pack	box	type	stock
IE8336000N160	16	0,084	100	3600	B	<input type="checkbox"/>
IE8336000M170	17 *	0,090	100	3600	B	<input type="checkbox"/>

90° elbow

835



Ref.	D x D	€	pack	box	type	stock
IE8356000N160	16 x 16	0,095	100	3000	B	<input type="checkbox"/>
IE8356000M170	17 x 17 *	0,104	100	2900	B	<input type="checkbox"/>

offtake with rubber

assembly requires 17 mm hole

838



Ref.	D	€	pack	box	type	stock
IE8386000N160	16	0,130	500	2000	B	<input type="checkbox"/>
IE8386000M170	17 *	0,134	500	2000	B	<input type="checkbox"/>
0EGDR8000N000	spare rubber	0,075	500	7000	B	<input type="checkbox"/>

3 way female threaded head

847



Ref.	D x G	€	pack	box	type	stock
IE84763F0N16D	16 x 1"	0,617	50	500	B	<input type="checkbox"/>
IE84763F0N20D	20 x 1"	0,640	50	450	B	<input type="checkbox"/>

4 way female threaded head

848



Ref.	D x G	€	pack	box	type	stock
IE84864F0N16D	16 x 1"	0,651	50	400	B	<input type="checkbox"/>
IE84864F0N20D	20 x 1"	0,693	50	300	B	<input type="checkbox"/>

6 way female threaded head

849



Ref.	D x G	€	pack	box	type	stock
IE84966F0N16D	16 x 1"	0,672	50	350	B	<input type="checkbox"/>
IE84966F0N20D	20 x 1"	0,705	50	200	B	<input type="checkbox"/>

\* brown

male adaptor

832



Ref.	D x G	€	pack	box	type	stock
IE83260M0N16B	16 x 1/2"	0,093	100	3000	B	<input type="checkbox"/>
IE83260M0N16C	16 x 3/4"	0,099	100	2000	B	<input type="checkbox"/>
IE83260M0M17B	17 x 1/2" *	0,106	100	3000	B	<input type="checkbox"/>
IE83260M0M17C	17 x 3/4" *	0,111	100	2000	B	<input type="checkbox"/>

tee

834



Ref.	D x D x D	€	pack	box	type	stock
IE8346000N160	16 x 16 x 16	0,108	100	2000	B	<input type="checkbox"/>
IE8346000M170	17 x 17 x 17 *	0,119	100	1900	B	<input type="checkbox"/>
IE8346000N200	20 x 20 x 20	0,350	100	1800	B	<input type="checkbox"/>

offtake with rubber

assembly requires 17 mm hole

837



Ref.	D	€	pack	box	type	stock
IE8376000N160	16	0,172	500	2000	B	<input type="checkbox"/>
IE8376000M170	17 *	0,179	500	2000	B	<input type="checkbox"/>
0EGOP00000170	spare rubber	0,125	500	6000	B	<input type="checkbox"/>

coupling with ring

841



Ref.	D x D	€	pack	box	type	stock
IE8416000N160	16 x 16 (POM)	0,119	100	3600	B	<input type="checkbox"/>
IE8416000N200	20 x 20 (POM)	0,132	100	2000	B	<input type="checkbox"/>
IE8412000N160	16 x 16 (PP)	0,084	100	3600	B	<input type="checkbox"/>
IE8412000N200	20 x 20 (PP)	0,089	100	2000	B	<input type="checkbox"/>

offtake with ring

assembly requires 12 mm hole with item FUS - FUT - PNZ

845



Ref.	D	€	pack	box	type	stock
IE8456000N160	16 (POM)	0,167	100	3600	B	<input type="checkbox"/>
IE8456000N200	20 (POM)	0,181	100	3000	B	<input type="checkbox"/>

tee with ring

829



Ref.	D x D x D	€	pack	box	type	stock
IE8296000N160	16 x 16 x 16	0,426	100	600	C	<input type="checkbox"/>
IE8296000N200	20 x 20 x 20	0,540	100	400	C	<input type="checkbox"/>

coupling



Ref.	D x D	€	pack	box	type	stock
IE8403000N160	16 x 16	<b>0,290</b>	100	500	C	
IE8403000N200	20 x 20	<b>0,354</b>	100	400	C	

male adaptor



Ref.	D x G	€	pack	box	type	stock
IE84230M0N16B	16 x 1/2"	<b>0,267</b>	100	600	C	
IE84230M0N16C	16 x 3/4"	<b>0,285</b>	100	500	C	
IE84230M0N20B	20 x 1/2"	<b>0,281</b>	100	500	C	
IE84230M0N20C	20 x 3/4"	<b>0,311</b>	100	400	C	

offtake with rubber

assembly requires 12 mm hole with item FUS - FUT - PNZ



Ref.	D	€	pack	box	type	stock
IE8433000N160	16	<b>0,176</b>	100	1000	C	
IE8433000N200	20	<b>0,210</b>	100	600	C	

elbow



Ref.	D x D	€	pack	box	type	stock
IE8392000N160	16 x 16	<b>0,330</b>	50	300	C	
IE8392000N200	20 x 20	<b>0,350</b>	50	200	C	

tee



Ref.	D x D x D	€	pack	box	type	stock
IE8443000N160	16 x 16 x 16	<b>0,564</b>	50	300	C	
IE8443000N200	20 x 20 x 20	<b>0,642</b>	50	200	C	

tee with male thread



Ref.	D x G x D	€	pack	box	type	stock
IE84630M0N16B	16 x 1/2" x 16	<b>0,472</b>	100	300	C	
IE84630M0N16C	16 x 3/4" x 16	<b>0,484</b>	50	300	C	
IE84630M0N20B	20 x 1/2" x 20	<b>0,498</b>	100	300	C	
IE84630M0N20C	20 x 3/4" x 20	<b>0,511</b>	50	200	C	

For Light Dripline  
look up Siplast™  
"Microirrigation 2011" price list



**Junior™ 35**



**Tandem™**



**Multibar™ 35**



**DP line™ 16 mm**



offtake with rubber / dripline

assembly requires 12 mm hole with item FUS - FUT - PNZ



Ref.	D	€	pack	box	type	stock
IVVDA2700N160	16	<b>0,470</b>	50	300	C	<input type="checkbox"/>
IVVDA2700N200	20	<b>0,470</b>	50	300	C	<input type="checkbox"/>



offtake with rubber / quick joint Pn4

assembly requires 12 mm hole with item FUS - FUT - PNZ



Ref.	D	€	pack	box	type	stock
IVVDE2700N160	16	<b>0,450</b>	50	300	C	<input type="checkbox"/>
IVVDE2700N200	20	<b>0,485</b>	50	300	C	<input type="checkbox"/>



offtake with rubber / insert

assembly requires 12 mm hole with item FUS - FUT - PNZ



Ref.	D	€	pack	box	type	stock
IVVDP2700N120	12	<b>0,450</b>	50	450	C	<input type="checkbox"/>
IVVDP2700N160	16	<b>0,450</b>	50	400	C	<input type="checkbox"/>
IVVDP2700N200	20	<b>0,450</b>	50	350	C	<input type="checkbox"/>
IVVDP2700N250	25	<b>0,470</b>	50	300	C	<input type="checkbox"/>



offtake with rubber / male thread

assembly requires 12 mm hole with item FUS - FUT - PNZ



Ref.	G	€	pack	box	type	stock
• IVVDM20M0N00B	1/2"	<b>0,450</b>	50	300	C	<input type="checkbox"/>
• IVVDM20M0N00C	3/4"	<b>0,450</b>	50	300	C	<input type="checkbox"/>



offtake with rubber / tape

per il montaggio effettuare foro: OOT = 12 mm - XLU = 18 mm



Ref.	D	€	pack	box	type	stock
IVVDT2700N00T	TAPE 16	<b>0,485</b>	50	300	C	<input type="checkbox"/>
IVVDT2700NXLU	TAPE 22	<b>0,530</b>	50	200	C	<input type="checkbox"/>



offtake with rubber / easy block

assembly requires 12 mm hole with item FUS - FUT - PNZ



Ref.	D	€	pack	box	type	stock
IVVDY2700N00T	TAPE 16	<b>0,450</b>	50	400	C	<input type="checkbox"/>
IVVDY2700N00U	TAPE 22	<b>0,470</b>	50	300	C	<input type="checkbox"/>



offtake layflat / easy block

assembly requires 14 mm hole with item FOR



Ref.	D	€	pack	box	type	stock
IVVLY2700N00T	TAPE 16	<b>0,560</b>	50	250	C	<input type="checkbox"/>
IVVLY2700N00U	TAPE 22	<b>0,600</b>	50	200	C	<input type="checkbox"/>

• NPT thread available



male thread / male thread



Ref.	G x G	€	pack	box	type	stock
• IVVMM27M0N200	1/2" x 1/2"	<b>0,430</b>	50	300	C	<input type="checkbox"/>
• IVVMM27M0N250	3/4" x 3/4"	<b>0,430</b>	50	250	C	<input type="checkbox"/>



male thread / dripline



Ref.	D x G	€	pack	box	type	stock
• IVVMA27M0N16B	16 x 1/2"	<b>0,450</b>	50	300	C	<input type="checkbox"/>
• IVVMA27M0N16C	16 x 3/4"	<b>0,450</b>	50	300	C	<input type="checkbox"/>
• IVVMA27M0N20B	20 x 1/2"	<b>0,450</b>	50	250	C	<input type="checkbox"/>
• IVVMA27M0N20C	20 x 3/4"	<b>0,450</b>	50	250	C	<input type="checkbox"/>



male thread / quick joint Pn4



Ref.	D x G	€	pack	box	type	stock
• IVVME27M0N16B	16 x 1/2"	<b>0,450</b>	50	300	C	<input type="checkbox"/>
• IVVME27M0N16C	16 x 3/4"	<b>0,450</b>	50	250	C	<input type="checkbox"/>
• IVVME27M0N20B	20 x 1/2"	<b>0,470</b>	50	250	C	<input type="checkbox"/>
• IVVME27M0N20C	20 x 3/4"	<b>0,470</b>	50	250	C	<input type="checkbox"/>



male thread / tape



Ref.	G x D	€	pack	box	type	stock
• IVVMT27M0N20T	1/2" x TAPE 16	<b>0,450</b>	50	300	C	<input type="checkbox"/>
• IVVMT27M0N25T	3/4" x TAPE 16	<b>0,450</b>	50	250	C	<input type="checkbox"/>
• IVVMT27M0N25U	3/4" x TAPE 22	<b>0,470</b>	50	200	C	<input type="checkbox"/>



male thread / insert



Ref.	D x G	€	pack	box	type	stock
• IVVMP27M0N12B	12 x 1/2"	<b>0,430</b>	50	400	C	<input type="checkbox"/>
• IVVMP27M0N12C	12 x 3/4"	<b>0,430</b>	50	300	C	<input type="checkbox"/>
• IVVMP27M0N16B	16 x 1/2"	<b>0,430</b>	50	400	C	<input type="checkbox"/>
• IVVMP27M0N16C	16 x 3/4"	<b>0,430</b>	50	300	C	<input type="checkbox"/>
• IVVMP27M0N20B	20 x 1/2"	<b>0,430</b>	50	300	C	<input type="checkbox"/>
• IVVMP27M0N20C	20 x 3/4"	<b>0,430</b>	50	300	C	<input type="checkbox"/>
• IVVMP27M0N25C	25 x 3/4"	<b>0,430</b>	50	250	C	<input type="checkbox"/>



offtake layflat / tape

assembly requires 14 mm hole with item FOR



Ref.	D	€	pack	box	type	stock
IVVLT2700N00T	TAPE 16	<b>0,610</b>	50	250	C	<input type="checkbox"/>
IVVLT2700N00U	TAPE 22	<b>0,620</b>	50	200	C	<input type="checkbox"/>

VGA



offtake with rubber/dripline  
assembly requires 17 mm hole



Ref.	D	€	pack	box	type	stock
IVVGA2700N160	16	0,500	50	300	C	<input type="checkbox"/>
IVVGA2700N200	20	0,500	50	300	C	<input type="checkbox"/>

VNT



offtake with rubber/tape  
assembly requires 15 mm hole



Ref.	D	€	pack	box	type	stock
IVVNT2700N00T	16 TAPE	0,560	50	250	C	<input type="checkbox"/>

VGT



offtake with rubber/tape  
assembly requires 17 mm hole



Ref.	D	€	pack	box	type	stock
IVVGT2700N00T	TAPE 16	0,490	50	300	C	<input type="checkbox"/>
IVVGT2700N00U	TAPE 22	0,500	50	200	C	<input type="checkbox"/>

VPT



insert / tape



Ref.	D x D	€	pack	box	type	stock
IVVPT2700N16T	16 x TAPE 16	0,450	50	300	C	<input type="checkbox"/>

VRA



offtake with rubber / dripline  
assembly requires 17 mm hole



Ref.	D	€	pack	box	type	stock
IVVRA2700N160	16	0,550	50	300	C	<input type="checkbox"/>
IVVRA2700N200	20	0,560	50	300	C	<input type="checkbox"/>

VRT



offtake with rubber / tape  
assembly requires 17 mm hole



Ref.	D	€	pack	box	type	stock
IVVRT2700N00T	TAPE 16	0,520	50	300	C	<input type="checkbox"/>
IVVRT2700N00U	TAPE 22	0,530	50	300	C	<input type="checkbox"/>

VGP



offtake with rubber / insert  
assembly requires 17 mm hole



Ref.	D	€	pack	box	type	stock
IVVGP2700N120	12	0,460	50	300	C	<input type="checkbox"/>
IVVGP2700N160	16	0,460	50	300	C	<input type="checkbox"/>
IVVGP2700N200	20	0,460	50	300	C	<input type="checkbox"/>

VRP



offtake with rubber / insert  
assembly requires 17 mm hole



Ref.	D	€	pack	box	type	stock
IVVRP2700N120	12	0,485	50	300	C	<input type="checkbox"/>
IVVRP2700N160	16	0,485	50	300	C	<input type="checkbox"/>
IVVRP2700N200	20	0,485	50	300	C	<input type="checkbox"/>

VEE



quick joint Pn4 / quick joint Pn4



Ref.	D x D	€	pack	box	type	stock
IVVEE2700N160	16 x 16	0,510	50	250	C	<input type="checkbox"/>
IVVEE2700N200	20 x 20	0,580	50	200	C	<input type="checkbox"/>

VTT



tape / tape



Ref.	D	€	pack	box	type	stock
IVVTT2700N00T	TAPE 16	0,490	50	250	C	<input type="checkbox"/>
IVVTT2700N00U	TAPE 22	0,550	50	150	C	<input type="checkbox"/>

VPP



insert / insert



Ref.	D x D	€	pack	box	type	stock
IVVPP2700N120	12 x 12	0,410	50	500	C	<input type="checkbox"/>
IVVPP2700N160	16 x 16	0,410	50	400	C	<input type="checkbox"/>
IVVPP2700N200	20 x 20	0,410	50	350	C	<input type="checkbox"/>
IVVPP2700N250	25 x 25	0,410	50	300	C	<input type="checkbox"/>

dripline / dripline

RAA



Ref.	D	€	pack	box	type	stock
IVRAA2700N160	16	<b>0,820</b>	50	150	C	<input type="checkbox"/>
IVRAA2700N200	20	<b>0,850</b>	50	150	C	<input type="checkbox"/>

offtake with rubber / dripline

assembly requires 12 mm hole with item FUS - FUT - PNZ

RDA



Ref.	D	€	pack	box	type	stock
IVRDA2700N160	16	<b>0,770</b>	50	150	C	<input type="checkbox"/>
IVRDA2700N200	20	<b>0,770</b>	50	150	C	<input type="checkbox"/>

offtake with rubber / male thread

assembly requires 12 mm hole with item FUS - FUT - PNZ

RDM



Ref.	G	€	pack	box	type	stock
IVRDM27M0N200	1/2"	<b>0,720</b>	50	150	C	<input type="checkbox"/>
IVRDM27M0N250	3/4"	<b>0,720</b>	50	150	C	<input type="checkbox"/>

offtake with rubber / insert

assembly requires 12 mm hole with item FUS - FUT - PNZ

RDP



Ref.	D	€	pack	box	type	stock
IVRDP2700N160	16	<b>0,720</b>	50	150	C	<input type="checkbox"/>
IVRDP2700N200	20	<b>0,720</b>	50	150	C	<input type="checkbox"/>
IVRDP2700N250	25	<b>0,720</b>	50	150	C	<input type="checkbox"/>

offtake with rubber / tape

assembly requires 12 mm hole with item FUS - FUT - PNZ

RDT



Ref.	D	€	pack	box	type	stock
IVRDT2700N00T	16	<b>0,810</b>	50	150	C	<input type="checkbox"/>

quick joint Pn4 / quick joint Pn4

REE



Ref.	D x D	€	pack	box	type	stock
IVREE2700N200	20 x 20	<b>0,850</b>	50	100	C	<input checked="" type="checkbox"/>
IVREE2700N250	25 x 25	<b>0,880</b>	50	100	C	<input checked="" type="checkbox"/>

female thread / female thread

RFF



Ref.	G x G	€	pack	box	type	stock
• IVRFF27F0N200	1/2" x 1/2"	<b>0,940</b>	50	150	C	<input checked="" type="checkbox"/>
• IVRFF27F0N250	3/4" x 3/4"	<b>0,940</b>	50	150	C	<input type="checkbox"/>

female thread / male thread

RFM



Ref.	G x G	€	pack	box	type	stock
• IVRFM27D0N200	1/2" x 1/2"	<b>0,820</b>	50	150	C	<input checked="" type="checkbox"/>
• IVRFM27D0N250	3/4" x 3/4"	<b>0,820</b>	50	150	C	<input checked="" type="checkbox"/>

female thread / insert

RFP



Ref.	D x G	€	pack	box	type	stock
IVRFP27F0N16B	16 x 1/2"	<b>0,820</b>	50	150	C	<input type="checkbox"/>
IVRFP27F0N16C	16 x 3/4"	<b>0,820</b>	50	150	C	<input type="checkbox"/>
IVRFP27F0N20B	20 x 1/2"	<b>0,820</b>	50	150	C	<input type="checkbox"/>
IVRFP27F0N20C	20 x 3/4"	<b>0,820</b>	50	150	C	<input type="checkbox"/>
IVRFP27F0N25B	25 x 1/2"	<b>0,820</b>	50	150	C	<input type="checkbox"/>
IVRFP27F0N25C	25 x 3/4"	<b>0,820</b>	50	150	C	<input type="checkbox"/>

female thread / tape

RFT



Ref.	G x D	€	pack	box	type	stock
IVRFT27F0N20T	1/2" x TAPE 16	<b>0,860</b>	50	150	C	<input type="checkbox"/>
IVRFT27F0N25T	3/4" x TAPE 16	<b>0,860</b>	50	150	C	<input type="checkbox"/>
IVRFT50F0N25U	3/4" x TAPE 22	<b>0,890</b>	50	100	C	<input type="checkbox"/>

male thread / insert

RMP



Ref.	D x G	€	pack	box	type	stock
• IVRMP27M0N16B	16 x 1/2"	<b>0,680</b>	50	150	C	<input type="checkbox"/>
• IVRMP27M0N16C	16 x 3/4"	<b>0,690</b>	50	150	C	<input checked="" type="checkbox"/>
• IVRMP27M0N20B	20 x 1/2"	<b>0,690</b>	50	150	C	<input type="checkbox"/>
• IVRMP27M0N20C	20 x 3/4"	<b>0,700</b>	50	150	C	<input type="checkbox"/>
• IVRMP27M0N25B	25 x 1/2"	<b>0,700</b>	50	150	C	<input type="checkbox"/>
• IVRMP27M0N25C	25 x 3/4"	<b>0,710</b>	50	150	C	<input type="checkbox"/>

male thread / tape

RMT



Ref.	G x D	€	pack	box	type	stock
• IVRMT27M0N20T	1/2" x TAPE 16	<b>0,780</b>	50	150	C	<input type="checkbox"/>
• IVRMT27M0N25T	3/4" x TAPE 16	<b>0,780</b>	50	150	C	<input type="checkbox"/>
• IVRMT27M0N25U	3/4" x TAPE 22	<b>0,990</b>	50	100	C	<input type="checkbox"/>

• NPT thread available



RME



male thread / quick joint Pn4



Ref.	D x G	€	pack	box	type	stock
• IVRME27M0N20B	20 x 1/2"	<b>0,830</b>	50	100	C	<input type="checkbox"/>
• IVRME27M0N20C	20 x 3/4"	<b>0,830</b>	50	100	C	<input type="checkbox"/>
• IVRME27M0N25B	25 x 1/2"	<b>0,830</b>	50	100	C	<input type="checkbox"/>
• IVRME27M0N25C	25 x 3/4"	<b>0,830</b>	50	100	C	<input type="checkbox"/>

RMA



male thread / dripline



Ref.	D x G	€	pack	box	type	stock
• IVRMA27M0N16B	16 x 1/2"	<b>0,810</b>	50	150	C	<input type="checkbox"/>
• IVRMA27M0N16C	16 x 3/4"	<b>0,810</b>	50	150	C	<input type="checkbox"/>
• IVRMA27M0N20B	20 x 1/2"	<b>0,810</b>	50	150	C	<input type="checkbox"/>
• IVRMA27M0N20C	20 x 3/4"	<b>0,810</b>	50	150	C	<input type="checkbox"/>

RMM



male thread / male thread



Ref.	G x G	€	pack	box	type	stock
• IVRMM27M0N200	1/2" x 1/2"	<b>0,680</b>	50	150	C	<input type="checkbox"/>
• IVRMM27M0N250	3/4" x 3/4"	<b>0,700</b>	50	150	C	<input type="checkbox"/>

RPT



insert / tape  
assembly requires 17 mm hole



Ref.	D x D	€	pack	box	type	stock
IVRPT2700N16T	16 x TAPE 16	<b>0,780</b>	50	150	C	<input type="checkbox"/>
IVRPT2700N20T	20 x TAPE 16	<b>0,780</b>	50	150	C	<input type="checkbox"/>

RPP



insert / insert



Ref.	D x D	€	pack	box	type	stock
IVRPP2700N120	12 x 12	<b>0,660</b>	50	150	C	<input type="checkbox"/>
IVRPP2700N160	16 x 16	<b>0,670</b>	50	150	C	<input type="checkbox"/>
IVRPP2700N200	20 x 20	<b>0,680</b>	50	150	C	<input type="checkbox"/>
IVRPP2700N250	25 x 25	<b>0,700</b>	50	150	C	<input type="checkbox"/>

RSP



offtake without rubber / insert  
assembly requires 10 mm hole with item FUS - FUT



Ref.	D	€	pack	box	type	stock
IVRSP2700N160	16	<b>0,670</b>	50	150	C	<input type="checkbox"/>
IVRSP2700N200	20	<b>0,680</b>	50	150	C	<input type="checkbox"/>
IVRSP2700N250	25	<b>0,700</b>	50	150	C	<input type="checkbox"/>

• NPT thread available

Group 4201

Fittings - Valves low pressure | ball valves

3FF



single nut PVC ball valve female / female  
available also grey



Ref.	G x G	€	pack	box	type	stock
• IV3FF11F0N250	¾" x ¾"	1,70	-	60	C	<input checked="" type="checkbox"/>
• IV3FF11F0N320	1" x 1"	1,70	-	60	C	<input checked="" type="checkbox"/>
• IV3FF11F0N400	1" ¼ x 1" ¼	6,00	-	40	C	<input checked="" type="checkbox"/>
• IV3FF11F0N500	1" ½ x 1" ½	6,45	-	25	C	<input checked="" type="checkbox"/>
• IV3FF11F0N630	2" x 2"	10,20	-	13	C	<input checked="" type="checkbox"/>

3MF



single nut PVC ball valve male / female valve  
available also grey



Ref.	G x G	€	pack	box	type	stock
• IV3MF11D0N250	¾" x ¾"	1,70	-	60	C	<input checked="" type="checkbox"/>
• IV3MF11D0N320	1" x 1"	1,70	-	60	C	<input checked="" type="checkbox"/>
• IV3MF11D0N400	1" ¼ x 1" ¼	5,90	-	40	C	<input checked="" type="checkbox"/>
• IV3MF11D0N500	1" ½ x 1" ½	6,15	-	25	C	<input checked="" type="checkbox"/>
• IV3MF11D0N630	2" x 2"	10,10	-	13	C	<input checked="" type="checkbox"/>

5FF



double nut PVC ball valve female / female



Ref.	G x G	€	pack	box	type	stock
IV5FF11F0N320	1" x 1"	2,99	-	50	C	<input type="checkbox"/>

Group 4201

Fittings - Valves low pressure | mini ball valves

SFM



mini ball valve female / male



Ref.	G x G	€	pack	box	type	stock
• IVSFM51D0N250	¾" x ¾"	0,460	50	300	C	<input checked="" type="checkbox"/>

SFF



mini ball valve female / female



Ref.	G x G	€	pack	box	type	stock
IVSFF51F0N250	¾" x ¾"	0,520	50	300	C	<input checked="" type="checkbox"/>

SFT



mini ball valve female thread / tape



Ref.	D x G	€	pack	box	type	stock
• IVSFT51F0N0TC	TAPE 16 x ¾"	0,520	50	300	C	<input checked="" type="checkbox"/>
• IVSFT51F0N0UC	TAPE 22 x ¾"	0,570	50	300	C	<input checked="" type="checkbox"/>

SFP



mini ball valve insert / female thread



Ref.	D x G	€	pack	box	type	stock
• IVSFP51F0N16C	16 x ¾"	0,460	50	300	C	<input checked="" type="checkbox"/>
• IVSFP51F0N20C	20 x ¾"	0,460	50	300	C	<input checked="" type="checkbox"/>
• IVSFP51F0N25C	25 x ¾"	0,460	50	300	C	<input checked="" type="checkbox"/>
• IVSFP31F0N32D	32 x 1"	1,07	50	150	C	<input checked="" type="checkbox"/>

SFY



mini ball valve female thread / tape "easy block"



Ref.	D x G	€	pack	box	type	stock
IVSFY51F0N0TC	TAPE 16 x ¾"	0,520	50	300	C	<input checked="" type="checkbox"/>
IVSFY51F0N0UC	TAPE 22 x ¾"	0,570	50	300	C	<input checked="" type="checkbox"/>

• NPT thread available

**IDS**  quick coupling valve

Ref.	D	€	pack	box	type	stock
• IVIDS20M0V025	3/4"	3,60	-	50	C	<input type="checkbox"/>
• IVIDS20M0V032	1"	3,60	-	50	C	<input type="checkbox"/>

**CHS**  key for quick coupling valve

Ref.	D	€	pack	box	type	stock
• IVCHS20M0N250	3/4"	1,80	-	100	C	<input type="checkbox"/>

**PRP**  pre-adjusted pressure regulator M/F flow rate 5,0 m³/h

Ref.	G x G	bar outlet	m³/h min	m³/h max	€	pack	box	type	stock
IVPRP30D0N11C	3/4" x 3/4"	1,1	0,8	5	4,00	1	125	C	<input type="checkbox"/>
IVPRP30D0N14C	3/4" x 3/4"	1,4	0,8	5	4,00	1	125	C	<input type="checkbox"/>

**DG5**  pre-adjusted pressure regulator M/F flow rate 1,8 m³/h

Ref.	G x G	bar outlet	m³/h min	m³/h max	€	pack	box	type	stock
IVDG5000N06C	3/4" x 3/4"	0,66	0,22	1,8	5,90	1	100	-	<input type="checkbox"/>
IVDG5000N10C	3/4" x 3/4"	1,03	0,22	1,8	5,90	1	100	-	<input type="checkbox"/>
IVDG5000N13C	3/4" x 3/4"	1,31	0,22	1,8	5,90	1	100	-	<input type="checkbox"/>

**SSE**  single effect air release valve

Ref.	G	outlet	€	pack	box	type	stock
• IVSSEN0M0N25C	3/4"	3/4"	10,20	1	25	C	<input type="checkbox"/>
• IVSSEN0M0N32C	1"	3/4"	10,20	1	25	C	<input type="checkbox"/>
• IVSSEN0M0N63D	2"	1"	21,60	1	12	C	<input type="checkbox"/>

**SDE**  double effect air release valve

Ref.	G	€	pack	box	type	stock
• IISDE00000320	1"	28,20	1	20	-	<input type="checkbox"/>
• IISDE00000630	2"	75,00	1	8	-	<input type="checkbox"/>

**SUF**  single effect air release valve with threaded outlet

Ref.	G	outlet	€	pack	box	type	stock
• IVSUF2AM0N250	3/4"	3/8"	6,80	1	80	C	<input type="checkbox"/>
• IVSUF2AM0N320	1"	3/8"	6,80	1	80	C	<input type="checkbox"/>

**SUP**  single effect air release valve with protected outlet

Ref.	G	outlet	€	pack	box	type	stock
• IVSUP2AM0N250	3/4"	-	7,10	1	80	C	<input type="checkbox"/>
• IVSUP2AM0N320	1"	-	7,10	1	80	C	<input type="checkbox"/>

**VFL**  end flush valve 3/4" female/female

Ref.	colour	opening bar	closing flow rate l/h	max. flow rate l/h	€	pack	box	type	stock
• IVVFL2000N250	orange	0,09	204	516	0,440	100	700	C	<input type="checkbox"/>
• IVVFL2000N25W	white	0,06	150	516	0,440	100	700	C	<input type="checkbox"/>

• NPT thread available

threaded cap

609



Ref.	G	€	pack	box	type	stock
• IR60920F0N200	½"	0,075	100	3000	B	■
• IR60920F0N250	¾"	0,098	100	2000	B	■
• IR60920F0N320	1"	0,109	50	1200	B	■
• IR60920F0N400	1" ¼	0,189	50	700	B	■
• IR60920F0N500	1" ½	0,436	20	400	B	■
• IR60920F0N630	2"	0,510	10	240	B	■
△ IR60920F0N750	2" ½	2,52	-	160	B	■
△ IR60920F0N900	3"	3,43	-	80	B	■
△ IR60920F0N110	4"	5,89	-	60	B	■

nipple

607



Ref.	G x G	€	pack	box	type	stock
• IR60720M0N200	½" x ½"	0,084	100	2400	B	■
• IR60720M0N250	¾" x ¾"	0,102	100	1400	B	■
• IR60720M0N320	1" x 1"	0,168	50	800	B	■
• IR60720M0N400	1" ¼ x 1" ¼	0,260	50	400	B	■
• IR60720M0N500	1" ½ x 1" ½	0,303	20	300	B	■
• IR60720M0N630	2" x 2"	0,541	10	180	B	■
IR60720M0N750	2" ½ x 2" ½	1,02	-	100	B	■
IR60720M0N900	3" x 3"	1,34	-	60	B	■
IR60720M0N110	4" x 4"	2,28	-	35	B	■

threaded plug

610



Ref.	G	€	pack	box	type	stock
• IR61020M0N200	½"	0,113	100	3000	B	■
• IR61020M0N250	¾"	0,126	100	2000	B	■
• IR61020M0N320	1"	0,163	50	1000	B	■
• IR61020M0N400	1" ¼	0,260	50	600	B	■
• IR61020M0N500	1" ½	0,300	20	460	B	■
• IR61020M0N630	2"	0,455	10	270	B	■
IR61020M0N750	2" ½	0,919	-	140	B	■
IR61020M0N900	3"	1,18	-	100	B	■

reducing nipple

619



Ref.	G x G	€	pack	box	type	stock
• IR61920M0N25B	¾" x ½"	0,097	100	1500	B	■
• IR61920M0N32B	1" x ½"	0,130	100	1000	B	■
• IR61920M0N32C	1" x ¾"	0,130	100	800	B	■
• IR61920M0N40B	1" ¼ x ½"	0,285	50	500	B	■
• IR61920M0N40C	1" ¼ x ¾"	0,227	50	500	B	■
• IR61920M0N40D	1" ¼ x 1"	0,227	50	400	B	■
• IR61920M0N50B	1" ½ x ½"	0,303	20	400	B	■
• IR61920M0N50C	1" ½ x ¾"	0,303	20	400	B	■
• IR61920M0N50D	1" ½ x 1"	0,303	20	360	B	■
• IR61920M0N50E	1" ½ x 1" ¼	0,303	20	340	B	■
• IR61920M0N63B	2" x ½"	0,509	10	240	B	■
• IR61920M0N63C	2" x ¾"	0,509	10	240	B	■
• IR61920M0N63D	2" x 1"	0,509	10	240	B	■
• IR61920M0N63E	2" x 1" ¼	0,509	10	200	B	■
• IR61920M0N63F	2" x 1" ½	0,509	10	200	B	■
• IR61920M0N75G	2" ½ x 2"	1,61	-	110	B	■
• IR61920M0N90H	3" x 2" ½	1,75	-	60	B	■

socket

620



Ref.	G x G	€	pack	box	type	stock
• IR62020F0N200	½" x ½"	0,185	100	1200	B	■
• IR62020F0N250	¾" x ¾"	0,194	100	700	B	■
• IR62020F0N320	1" x 1"	0,242	50	400	B	■
• IR62020F0N400	1" ¼ x 1" ¼	0,733	25	250	B	■
• IR62020F0N500	1" ½ x 1" ½	1,11	20	200	B	■
• IR62020F0N630	2" x 2"	1,28	10	100	B	■
△ IR62020F0N750	2" ½ x 2" ½	4,91	-	70	B	■
△ IR62020F0N900	3" x 3"	5,53	-	50	B	■

male / female reducer

622



Ref.	G x G	€	pack	box	type	stock
IR62220D0N20A	½" x ¾"	0,248	100	2000	B	■
IR62220D0N25B	¾" x ½"	0,303	100	1400	B	■
IR62220D0N32B	1" x ½"	0,227	50	700	B	■
• IR62220D0N32C	1" x ¾"	0,227	50	700	B	■
IR62220D0N40C	1" ¼ x ¾"	0,411	25	400	B	■
• IR62220D0N40D	1" ¼ x 1"	0,411	25	300	B	■
IR62220D0N50E	1" ½ x 1" ¼	0,502	20	240	B	■
IR62220D0N63F	2" x 1" ½	0,758	10	180	B	■

reducing socket

621



Ref.	G x G	€	pack	box	type	stock
IR62120F0N20A	½" x ¾"	0,185	100	2.000	B	■
• IR62120F0N25B	¾" x ½"	0,185	100	800	B	■
• IR62120F0N32B	1" x ½"	0,238	50	500	B	■
• IR62120F0N32C	1" x ¾"	0,238	50	500	B	■
• IR62120F0N40D	1" ¼ x 1"	0,653	25	250	B	■
• IR62120F0N50E	1" ½ x 1" ¼	0,919	20	200	B	■
• IR62120F0N63F	2" x 1" ½	1,22	10	140	B	■
△ IR62120F0N75G*	2" ½ x 2"	3,99	-	80	B	■
△ IR62120F0N90H*	3" x 2" ½	5,83	-	60	B	■

by-pass adaptor male thread / victaulic

507



Ref.	G x G	€	pack	box	type	stock
IY50720D0N630	2" x 2"	0,900	10	120	B	■
IY50720D0N900	3" x 3"	1,30	1	60	B	■

△ With stainless steel reinforcing ring • NPT thread available

male / female bush

623



Ref.	G x G	€	pack	box	type	stock
IR62320D0N20A	½" x ¾"	0,185	100	-	-	<input type="checkbox"/>
• IR62320D0N25B	¾" x 1"	0,185	100	2000	B	<input type="checkbox"/>
• IR62320D0N32B	1" x ½"	0,194	50	1100	B	<input type="checkbox"/>
• IR62320D0N32C	1" x ¾"	0,206	50	1100	B	<input type="checkbox"/>
• IR62320D0N40B	1" ¼ x ½"	0,337	50	600	B	<input type="checkbox"/>
• IR62320D0N40C	1" ¼ x ¾"	0,337	50	600	B	<input type="checkbox"/>
• IR62320D0N40D	1" ¼ x 1"	0,318	50	600	B	<input type="checkbox"/>
• IR62320D0N50C	1" ½ x ¾"	0,365	20	540	B	<input type="checkbox"/>
• IR62320D0N50D	1" ½ x 1"	0,346	20	540	B	<input type="checkbox"/>
• IR62320D0N50E	1" ½ x 1" ¼	0,346	20	540	B	<input type="checkbox"/>
• IR62320D0N63C	2" x ¾"	0,896	10	260	B	<input type="checkbox"/>
• IR62320D0N63D	2" x 1"	0,896	10	260	B	<input type="checkbox"/>
• IR62320D0N63E	2" x 1" ¼	0,896	10	260	B	<input type="checkbox"/>
• IR62320D0N63F	2" x 1" ½	1,00	10	260	B	<input type="checkbox"/>
IR62320D0N75G	2" ½ x 2"	1,80	-	140	B	<input type="checkbox"/>
IR62320D0N90G	3" x 2"	2,84	-	100	B	<input type="checkbox"/>
IR62320D0N90H	3" x 2" ½	2,79	-	100	B	<input type="checkbox"/>

male / female enlarging piece

625



Ref.	G x G	€	pack	box	type	stock
• IR62520D0N20C	½" x ¾"	0,411	100	800	B	<input type="checkbox"/>
• IR62520D0N20D	½" x 1"	0,541	50	500	B	<input type="checkbox"/>
• IR62520D0N20E	½" x 1" ¼	0,643	25	300	B	<input type="checkbox"/>
• IR62520D0N20F	½" x 1" ½	0,643	10	280	B	<input type="checkbox"/>
• IR62520D0N25D	¾" x 1"	0,541	50	500	B	<input type="checkbox"/>
• IR62520D0N25E	¾" x 1" ¼	0,662	25	300	B	<input type="checkbox"/>
• IR62520D0N25F	¾" x 1" ½	0,662	20	240	B	<input type="checkbox"/>
• IR62520D0N25G	¾" x 2"	0,902	10	140	B	<input type="checkbox"/>
• IR62520D0N32E	1" x 1" ¼	0,662	25	300	B	<input type="checkbox"/>
• IR62520D0N32F	1" x 1" ½	0,730	20	240	B	<input type="checkbox"/>
• IR62520D0N32G	1" x 2"	0,902	10	150	B	<input type="checkbox"/>
• IR62520D0N40F	1" ¼ x 1" ½	0,937	20	240	B	<input type="checkbox"/>
• IR62520D0N40G	1" ¼ x 2"	0,937	10	160	B	<input type="checkbox"/>
• IR62520D0N50G	1" ½ x 2"	0,961	10	110	B	<input type="checkbox"/>

female / female elbow

626



Ref.	G x G	€	pack	box	type	stock
• IR62620F0N200	½" x ½"	0,411	100	800	B	<input type="checkbox"/>
• IR62620F0N250	¾" x ¾"	0,476	50	500	B	<input type="checkbox"/>
• IR62620F0N320	1" x 1"	0,606	50	300	B	<input type="checkbox"/>
• IR62620F0N400	1" ¼ x 1" ¼	0,962	10	150	B	<input type="checkbox"/>
• IR62620F0N500	1" ½ x 1" ½	2,34	10	120	B	<input type="checkbox"/>
• IR62620F0N630	2" x 2"	2,86	10	70	B	<input type="checkbox"/>
Δ IR62620F0N750	2" ½ x 2" ½	9,14	-	36	-	<input type="checkbox"/>
Δ IR62620F0N900	3" x 3"	10,80	-	18	-	<input type="checkbox"/>

male / female elbow

627



Ref.	G x G	€	pack	box	type	stock
IR62720D0N200	½" x ½"	0,265	100	800	B	<input type="checkbox"/>
IR62720D0N250	¾" x ¾"	0,337	50	500	B	<input type="checkbox"/>
IR62720D0N320	1" x 1"	0,384	25	300	B	<input type="checkbox"/>

female tee

630



Ref.	G x G x G	€	pack	box	type	stock
• IR63020F0N200	½" x ½" x ½"	0,519	50	500	B	<input type="checkbox"/>
• IR63020F0N250	¾" x ¾" x ¾"	0,649	50	300	B	<input type="checkbox"/>
• IR63020F0N320	1" x 1" x 1"	0,758	25	200	B	<input type="checkbox"/>
• IR63020F0N400	1" ¼ x 1" ¼ x 1" ¼	1,23	10	100	B	<input type="checkbox"/>
• IR63020F0N500	1" ½ x 1" ½ x 1" ½	3,00	10	80	B	<input type="checkbox"/>
• IR63020F0N630	2" x 2" x 2"	3,81	10	40	B	<input type="checkbox"/>
Δ IR63020F0N750	2" ½ x 2" ½ x 2" ½	10,80	-	24	-	<input type="checkbox"/>
Δ IR63020F0N900	3" x 3" x 3"	13,20	-	16	-	<input type="checkbox"/>

female cross

633



Ref.	G x G x G x G	€	pack	box	type	stock
• IR63320F0N630	2" x 2" x 2" x 2"	14,70	5	30	B	<input type="checkbox"/>
Δ IR63320F0N900	3" x 3" x 3" x 3"	22,10	-	12	B	<input type="checkbox"/>

light nipple

307



Ref.	G x G	€	pack	box	type	stock
IR30720M0N250	¾" x ¾"	0,093	-	900	C	<input type="checkbox"/>
IR30720M0N320	1" x 1"	0,122	-	450	C	<input type="checkbox"/>

male tee

605



Ref.	G x G x G	€	pack	box	type	stock
IR60520M0N200	½" x ½" x ½"	0,30	100	1000	B	<input type="checkbox"/>
IR60520M0N20C	½" x ¾" x ½"	0,30	50	1000	B	<input type="checkbox"/>
IR60520M0N250	¾" x ¾" x ¾"	0,33	100	600	B	<input type="checkbox"/>
IR60520M0N25D	¾" x 1" x ¾"	0,40	50	500	B	<input type="checkbox"/>
IR60520M0N320	1" x 1" x 1"	0,44	25	300	B	<input type="checkbox"/>
IR60520M0N32E	1" x 1" ¼ x 1"	0,72	25	250	B	<input type="checkbox"/>
IR60520M0N400	1" ¼ x 1" ¼ x 1" ¼	0,82	20	160	B	<input type="checkbox"/>
IR60520M0N630	2" x 2" x 2"	3,20	-	55	B	<input type="checkbox"/>
IR60520M0N750	2" ½ x 2" ½ x 2" ½	4,30	-	35	B	<input type="checkbox"/>
IR60520M0N900	3" x 3" x 3"	5,20	-	20	B	<input type="checkbox"/>
IR60520M0N110	4" x 4" x 4"	6,80	-	9	B	<input type="checkbox"/>

light cap

309



Ref.	G	€	pack	box	type	stock
IR30920F0N250	¾"	0,080	-	1400	C	<input type="checkbox"/>
IR30920F0N320	1"	0,104	-	800	C	<input type="checkbox"/>

Δ With stainless steel reinforcing ring • NPT thread available

752



grey male adaptor  
black available on request



Ref.	D x G	€	pack	box	type	stock
IP75220M0G13B	13 x 1/2"	0,375	100	2000	B	
IP75220M0G16B	16 x 1/2"	0,380	100	1600	B	
IP75220M0G16C	16 x 3/4"	0,397	100	1200	B	
IP75220M0G20B	20 x 1/2"	0,397	50	1400	B	
IP75220M0G20C	20 x 3/4"	0,420	100	1000	B	
IP75220M0G20D	20 x 1"	0,448	100	700	B	
IP75220M0G25B	25 x 1/2"	0,482	100	800	B	
IP75220M0G25C	25 x 3/4"	0,482	100	800	B	
IP75220M0G25D	25 x 1"	0,499	50	600	B	
IP75220M0G25E	25 x 1" 1/4	0,760	100	600	B	
IP75220M0G30D	30 x 1"	0,590	50	500	B	
IP75220M0G30E	30 x 1" 1/4	0,760	50	300	-	
IP75220M0G32D	32 x 1"	0,531	50	400	B	
IP75220M0G32E	32 x 1" 1/4	0,640	50	300	B	
IP75220M0G35E	35 x 1" 1/4	0,799	25	300	-	
IP75220M0G38F	38 x 1" 1/2	0,981	25	250	B	
IP75220M0G40D	40 x 1"	0,862	25	250	-	
IP75220M0G40E	40 x 1" 1/4	0,890	25	250	B	
IP75220M0G40F	40 x 1" 1/2	1,18	25	200	B	
IP75220M0G50F	50 x 1" 1/2	1,23	10	160	B	
IP75220M0G50G	50 x 2"	1,23	10	140	B	

753



grey reducing coupling  
black available on request



Ref.	D x D	€	pack	box	type	stock
IP7532000G20A	20 x 16	0,499	100	1100	B	
IP7532000G25A	25 x 16	0,562	100	800	B	
IP7532000G25B	25 x 20	0,562	50	700	B	
IP7532000G32C	32 x 25	0,748	50	400	B	
IP7532000G40D	40 x 32	1,02	25	250	B	

754



grey coupling  
black available on request



Ref.	D x D	€	pack	box	type	stock
IP7542000G160	16 x 16	0,482	100	1400	B	
IP7542000G200	20 x 20	0,527	100	1000	B	
IP7542000G250	25 x 25	0,590	50	500	B	
IP7542000G320	32 x 32	0,760	50	300	B	
IP7542000G400	40 x 40	1,02	25	200	B	



	page
Compression fittings Connecto™ Plus	64-67
Compression fittings Connecto™	68-71
Clamp saddles	72-74
PVC fittings	76-82
PVC valves	83



female adaptor

901



Ref.	D x G	PFA (PN)	€	pack	box	type	stock
• IQ90120F0U16B	16 x 1/2"	16	0,75	20	340	C	■
• IQ90120F0U16C	16 x 3/4"	16	0,75	20	300	C	■
• IQ90120F0U20B	20 x 1/2"	16	0,99	20	220	C	■
• IQ90120F0U20C	20 x 3/4"	16	0,99	20	200	-	■
• IQ90120F0U20D	20 x 1"	16	1,15	20	160	B	■
• IQ90120F0U25B	25 x 1/2"	16	1,15	10	260	B	■
• IQ90120F0U25C	25 x 3/4"	16	1,15	10	260	B	■
• IQ90120F0U25D	25 x 1"	16	1,15	10	240	B	■
• IQ90120F0U32B	32 x 1/2"	16	1,46	10	200	B	■
• IQ90120F0U32C	32 x 3/4"	16	1,46	10	180	B	■
• IQ90120F0U32D	32 x 1"	16	1,46	10	160	B	■
• IQ90120F0U32E	32 x 1" 1/4*	16	2,02	10	140	B	■
• IQ90120F0U40D	40 x 1"	16	2,50	5	90	B	■
• IQ90120F0U40E	40 x 1" 1/4*	16	2,50	5	90	B	■
• IQ90120F0U40F	40 x 1" 1/2*	16	2,60	5	90	B	■
• IQ90120F0U50E	50 x 1" 1/4*	16	3,25	5	55	B	■
• IQ90120F0U50F	50 x 1" 1/2*	16	3,25	5	55	B	■
• IQ90120F0U50G	50 x 2**	16	3,48	5	50	B	■
• IQ90120F0U63E	63 x 1" 1/4	16	4,60	5	30	B	■
• IQ90120F0U63F	63 x 1" 1/2*	16	4,60	5	30	B	■
• IQ90120F0U63G	63 x 2**	16	4,60	5	30	B	■
• IQ90120F0U75G	75 x 2**	10	9,15	1	18	B	■
• IQ90120F0U75H	75 x 2" 1/2*	10	9,15	1	18	B	■
• IQ90120F0U90H	90 x 2" 1/2*	10	11,40	1	12	B	■
• IQ90120F0U90I	90 x 3**	10	11,40	1	12	B	■
• IQ90120F0U11I	110 x 3**	10	26,80	1	6	B	■
• IQ90120F0U11L	110 x 4**	10	26,80	1	6	B	■

coupling

910



Ref.	D x D	PFA (PN)	€	pack	box	type	stock
IQ9102000U160	16 x 16	16	1,15	20	240	C	■
IQ9102000U200	20 x 20	16	1,50	20	140	C	■
IQ9102000U250	25 x 25	16	1,89	10	160	B	■
IQ9102000U320	32 x 32	16	2,42	10	100	B	■
IQ9102000U400	40 x 40	16	3,96	5	55	B	■
IQ9102000U500	50 x 50	16	5,39	5	30	B	■
IQ9102000U630	63 x 63	16	7,47	5	20	B	■
IQ9102000U750	75 x 75	10	14,00	1	10	B	■
IQ9102000U900	90 x 90	10	17,60	1	7	B	■
IQ9102000U110	110 x 110	10	37,00	1	6	J	■

male adaptor

911



Ref.	D x G	PFA (PN)	€	pack	box	type	stock
• IQ91120M0U16B	16 x 1/2"	16	0,77	20	400	C	■
• IQ91120M0U16C	16 x 3/4"	16	0,77	20	380	C	■
• IQ91120M0U20B	20 x 1/2"	16	0,91	20	240	C	■
• IQ91120M0U20C	20 x 3/4"	16	0,91	20	220	C	■
• IQ91120M0U20D	20 x 1"	16	1,05	20	200	-	■
• IQ91120M0U25B	25 x 1/2"	16	1,05	10	280	B	■
• IQ91120M0U25C	25 x 3/4"	16	1,05	10	280	B	■
• IQ91120M0U25D	25 x 1"	16	1,05	10	260	B	■
• IQ91120M0U32C	32 x 3/4"	16	1,33	10	180	B	■
• IQ91120M0U32D	32 x 1"	16	1,33	10	160	B	■
• IQ91120M0U32E	32 x 1" 1/4	16	1,48	10	160	B	■
• IQ91120M0U40D	40 x 1"	16	2,46	5	90	B	■
• IQ91120M0U40E	40 x 1" 1/4	16	2,46	5	90	B	■
• IQ91120M0U40F	40 x 1" 1/2	16	2,46	5	90	B	■
• IQ91120M0U50D	50 x 1"	16	3,30	5	60	-	■
• IQ91120M0U50E	50 x 1" 1/4	16	3,30	5	60	B	■
• IQ91120M0U50F	50 x 1" 1/2	16	3,30	5	60	B	■
• IQ91120M0U50G	50 x 2"	16	3,37	5	50	B	■
• IQ91120M0U63F	63 x 1" 1/2	16	4,57	5	30	B	■
• IQ91120M0U63G	63 x 2"	16	4,57	5	30	B	■
• IQ91120M0U63H	63 x 2" 1/2	16	4,57	5	30	B	■
• IQ91120M0U75G	75 x 2"	10	9,10	1	18	B	■
• IQ91120M0U75H	75 x 2" 1/2	10	9,10	1	18	B	■
• IQ91120M0U75I	75 x 3"	10	9,45	1	15	B	■
• IQ91120M0U90G	90 x 2"	10	10,80	1	12	B	■
• IQ91120M0U90H	90 x 2" 1/2	10	10,80	1	12	B	■
• IQ91120M0U90I	90 x 3"	10	10,80	1	12	B	■
• IQ91120M0U90L	90 x 4"	10	11,70	1	12	B	■
• IQ91120M0U11G	110 x 2"	10	21,00	1	6	-	■
• IQ91120M0U11I	110 x 3"	10	21,00	1	6	B	■
• IQ91120M0U11L	110 x 4"	10	21,00	1	6	B	■

reducer coupling

912



Ref.	D x D	PFA (PN)	€	pack	box	type	stock
IQ9122000U20A	20 x 16	16	1,57	20	160	C	■
IQ9122000U25B	25 x 20	16	1,71	10	200	B	■
IQ9122000U32C	32 x 25	16	2,23	10	120	B	■
IQ9122000U40C	40 x 25	16	3,84	5	80	B	■
IQ9122000U40D	40 x 32	16	3,84	5	70	B	■
IQ9122000U50B	50 x 20	16	4,99	5	60	B	■
IQ9122000U50C	50 x 25	16	4,99	5	60	B	■
IQ9122000U50D	50 x 32	16	4,99	5	40	B	■
IQ9122000U50E	50 x 40	16	4,99	5	40	B	■
IQ9122000U63D	63 x 32	16	7,10	5	30	B	■
IQ9122000U63E	63 x 40	16	7,10	5	30	B	■
IQ9122000U63F	63 x 50	16	7,10	5	25	B	■
IQ9122000U75F	75 x 50	10	12,80	1	15	B	■
IQ9122000U75G	75 x 63	10	12,80	1	15	B	■
IQ9122000U90G	90 x 63	10	16,90	1	8	B	■
IQ9122000U90H	90 x 75	10	17,60	1	8	B	■
IQ9122000U11I	110 x 90	10	35,40	1	6	J	■

\* With stainless steel reinforcing ring

• NPT thread available



914



90° tee



Ref.	D x D x D	PFA (PN)	€	pack	box	type	stock
IQ9142000U160	16 x 16 x 16	16	1,52	20	140	C	■
IQ9142000U200	20 x 20 x 20	16	2,06	20	80	C	■
IQ9142000U250	25 x 25 x 25	16	2,73	10	80	B	■
IQ9142000U320	32 x 32 x 32	16	3,53	10	50	B	■
IQ9142000U400	40 x 40 x 40	16	5,84	5	35	B	■
IQ9142000U500	50 x 50 x 50	16	7,96	5	15	B	■
IQ9142000U630	63 x 63 x 63	16	11,40	4	12	B	■
IQ9142000U750	75 x 75 x 75	10	19,90	1	5	B	■
IQ9142000U900	90 x 90 x 90	10	27,40	1	3	B	■
IQ9142000U110	110 x 110 x 110	10	52,30	1	2	J	■

916



90° tee  
with male threaded offtake



Ref.	D x G x D	PFA (PN)	€	pack	box	type	stock
• IQ91620M0U16B	16 x 1/2" x 16	16	1,66	20	160	C	■
• IQ91620M0U16C	16 x 3/4" x 16	16	1,66	20	160	C	■
• IQ91620M0U20B	20 x 1/2" x 20	16	1,74	20	100	C	■
• IQ91620M0U20C	20 x 3/4" x 20	16	1,74	20	100	C	■
• IQ91620M0U25B	25 x 1/2" x 25	16	2,27	10	120	B	■
• IQ91620M0U25C	25 x 3/4" x 25	16	2,27	10	120	B	■
• IQ91620M0U25D	25 x 1" x 25	16	2,27	10	100	B	■
• IQ91620M0U32C	32 x 3/4" x 32	16	2,85	10	70	B	■
• IQ91620M0U32D	32 x 1" x 32	16	2,85	10	70	B	■
• IQ91620M0U32E	32 x 1" 1/4 x 32	16	2,85	10	60	B	■
• IQ91620M0U40E	40 x 1" 1/4 x 40	16	4,99	5	35	B	■
• IQ91620M0U40F	40 x 1" 1/2 x 40	16	4,99	5	35	B	■
• IQ91620M0U50E	50 x 1" 1/4 x 50	16	7,06	5	20	B	■
• IQ91620M0U50F	50 x 1" 1/2 x 50	16	7,06	5	20	B	■
• IQ91620M0U50G	50 x 2" x 50	16	7,06	5	20	B	■
• IQ91620M0U63G	63 x 2" x 63	16	13,80	4	12	B	■
• IQ91620M0U75H	75 x 2" 1/2 x 75	10	16,90	1	8	B	■
• IQ91620M0U75I	75 x 3" x 75	10	16,90	1	7	B	■
• IQ91620M0U90I	90 x 3" x 90	10	24,60	1	4	B	■
• IQ91620M0U90L	90 x 4" x 90	10	24,60	1	4	B	■
• IQ91620M0U11L	110 x 4" x 110	10	39,80	1	2	B	■

913



90° elbow



Ref.	D x D	PFA (PN)	€	pack	box	type	stock
IQ9132000U160	16 x 16	16	1,24	20	240	C	■
IQ9132000U200	20 x 20	16	1,57	20	120	C	■
IQ9132000U250	25 x 25	16	1,92	10	140	B	■
IQ9132000U320	32 x 32	16	2,39	10	80	B	■
IQ9132000U400	40 x 40	16	4,20	5	50	B	■
IQ9132000U500	50 x 50	16	5,83	5	25	B	■
IQ9132000U630	63 x 63	16	7,50	5	15	B	■
IQ9132000U750	75 x 75	10	14,50	1	8	B	■
IQ9132000U900	90 x 90	10	18,00	1	5	B	■
IQ9132000U110	110 x 110	10	35,20	1	4	J	■

915



90° tee  
with female threaded offtake



Ref.	D x G x D	PFA (PN)	€	pack	box	type	stock
• IQ91520F0U16B	16 x 1/2" x 16	16	1,30	20	160	C	■
• IQ91520F0U16C	16 x 3/4" x 16	16	1,30	20	160	C	■
• IQ91520F0U20B	20 x 1/2" x 20	16	1,65	20	100	C	■
• IQ91520F0U20C	20 x 3/4" x 20	16	1,65	20	80	C	■
• IQ91520F0U25B	25 x 1/2" x 25	16	2,10	10	120	B	■
• IQ91520F0U25C	25 x 3/4" x 25	16	2,10	10	110	B	■
• IQ91520F0U25D	25 x 1" x 25	16	2,33	10	100	B	■
• IQ91520F0U32C	32 x 1/2" x 32	16	2,73	10	80	B	■
• IQ91520F0U32D	32 x 3/4" x 32	16	2,73	10	70	B	■
• IQ91520F0U32D	32 x 1" x 32	16	2,73	10	60	B	■
• IQ91520F0U32E	32 x 1" 1/4 x 32	16	2,73	10	60	B	■
• IQ91520F0U40D	40 x 1" x 40	16	5,05	5	35	B	■
• IQ91520F0U40E	40 x 1" 1/4 x 40*	16	5,20	5	35	B	■
• IQ91520F0U40F	40 x 1" 1/2 x 40*	16	5,50	5	35	B	■
• IQ91520F0U50E	50 x 1" 1/4 x 50*	16	6,80	5	25	B	■
• IQ91520F0U50F	50 x 1" 1/2 x 50*	16	6,80	5	20	B	■
• IQ91520F0U50G	50 x 2" x 50*	16	7,20	5	20	B	■
• IQ91520F0U63F	63 x 1" 1/2 x 63*	16	10,00	4	12	B	■
• IQ91520F0U63G	63 x 2" x 63*	16	10,00	4	12	B	■
• IQ91520F0U75G	75 x 2" x 75*	10	16,80	1	7	B	■
• IQ91520F0U75H	75 x 2" 1/2 x 75*	10	16,80	1	7	B	■
• IQ91520F0U75I	75 x 3" x 75*	10	16,80	1	7	B	■
• IQ91520F0U90H	90 x 2" 1/2 x 90*	10	25,00	1	4	B	■
• IQ91520F0U90I	90 x 3" x 90*	10	25,00	1	4	B	■
• IQ91520F0U90L	90 x 4" x 90*	10	25,00	1	4	B	■
• IQ91520F0U11L	110 x 4" x 110*	10	37,80	1	2	B	■

918



90° elbow  
with female threaded offtake



Ref.	D x G	PFA (PN)	€	pack	box	type	stock
• IQ91820F0U16B	16 x 1/2"	16	0,96	20	300	C	■
• IQ91820F0U16C	16 x 3/4"	16	0,96	20	240	C	■
• IQ91820F0U20B	20 x 1/2"	16	1,18	20	180	C	■
• IQ91820F0U20C	20 x 3/4"	16	1,18	20	160	C	■
• IQ91820F0U25B	25 x 1/2"	16	1,48	10	220	B	■
• IQ91820F0U25C	25 x 3/4"	16	1,48	10	220	B	■
• IQ91820F0U25D	25 x 1"	16	1,48	10	180	B	■
• IQ91820F0U32C	32 x 3/4"	16	1,74	10	140	B	■
• IQ91820F0U32D	32 x 1"	16	1,74	10	140	B	■
• IQ91820F0U32E	32 x 1" 1/4	16	1,74	10	110	B	■
• IQ91820F0U40D	40 x 1"	16	3,43	5	70	B	■
• IQ91820F0U40E	40 x 1" 1/4*	16	3,43	5	70	B	■
• IQ91820F0U50F	50 x 1" 1/2*	16	4,57	5	40	B	■
• IQ91820F0U50G	50 x 2"	16	4,57	5	35	B	■
• IQ91820F0U63F	63 x 1" 1/2*	16	6,30	5	20	B	■
• IQ91820F0U63G	63 x 2"	16	6,30	5	20	B	■
• IQ91820F0U75H	75 x 2" 1/2	10	11,30	1	12	B	■
• IQ91820F0U75I	75 x 3"	10	11,30	1	12	B	■
• IQ91820F0U90I	90 x 3"	10	20,80	1	8	B	■
• IQ91820F0U90L	90 x 4"	10	20,80	1	8	B	■
• IQ91820F0U11L	110 x 4"	10	33,80	1	6	J	■

\* With stainless steel reinforcing ring

• NPT thread available

919



90° elbow  
with male threaded offtake



Ref.	D x G	PFA (PN)	€	pack	box	type	stock
• IQ91920M0U16B	16 x 1/2"	16	1,00	20	320	C	■
• IQ91920M0U16C	16 x 3/4"	16	1,00	20	320	C	■
• IQ91920M0U20B	20 x 1/2"	16	1,06	20	200	C	■
• IQ91920M0U20C	20 x 3/4"	16	1,06	20	180	C	■
• IQ91920M0U25B	25 x 1/2"	16	1,28	10	240	B	■
• IQ91920M0U25C	25 x 3/4"	16	1,28	10	240	B	■
• IQ91920M0U25D	25 x 1"	16	1,28	10	220	B	■
• IQ91920M0U32C	32 x 3/4"	16	1,65	10	160	B	■
• IQ91920M0U32D	32 x 1"	16	1,65	10	140	B	■
• IQ91920M0N32E	32 x 1" 1/4	16	1,65	10	140	B	■
• IQ91920M0U40D	40 x 1"	16	2,70	5	80	-	■
• IQ91920M0U40E	40 x 1" 1/4	16	2,70	5	80	B	■
• IQ91920M0N40F	40 x 1" 1/2	16	2,70	5	70	B	■
• IQ91920M0U50F	50 x 1" 1/2	16	3,60	5	40	B	■
• IQ91920M0N50G	50 x 2"	16	3,60	5	40	B	■
• IQ91920M0U63G	63 x 2"	16	5,00	5	25	B	■
• IQ91920M0N63H	63 x 2" 1/2	16	5,00	5	25	B	■
• IQ91920M0U75H	75 x 2" 1/2	10	10,50	1	14	B	■
• IQ91920M0U75I	75 x 3"	10	10,50	1	12	B	■
• IQ91920M0U90I	90 x 3"	10	14,00	1	8	B	■
• IQ91920M0U90L	90 x 4"	10	14,50	1	8	B	■
• IQ91920M0U11L	110 x 4"	10	25,80	1	6	J	■

flanged adaptor

920



Ref.	D x G	PFA (PN)	€	pack	box	type	stock
IQ92020D0U50G	50 x 2" (dn 50)	10	18,00	1	8	C	■
IQ92020D0U63G	63 x 2" (dn 50)	10	19,50	1	8	C	■
IQ92020D0U63H	63 x 2" 1/2 (dn 65)	10	23,00	1	8	C	■
IQ92020D0U75H	75 x 2" 1/2 (dn 65)	10	25,00	1	8	B	■
IQ92020D0U75I	75 x 3" (dn 80)	10	27,00	1	8	B	■
IQ92020D0U90I	90 x 3" (dn 80)	10	30,00	1	8	B	■
IQ92020D0U90L	90 x 4" (dn 100)	10	34,00	1	6	B	■
IQ92020D0U11L	110 x 4" (dn 100)	10	38,00	1	5	B	■

end plug

921



Ref.	D	PFA (PN)	€	pack	box	type	stock
IQ9212000U160	16	16	0,84	20	500	C	■
IQ9212000U200	20	16	1,07	20	260	C	■
IQ9212000U250	25	16	1,18	10	300	B	■
IQ9212000U320	32	16	1,45	10	200	B	■
IQ9212000U400	40	16	2,43	5	100	B	■
IQ9212000U500	50	16	3,60	5	65	B	■
IQ9212000U630	63	16	4,90	5	35	B	■
IQ9212000U750	75	10	12,50	1	20	B	■
IQ9212000U900	90	10	13,90	1	12	B	■
IQ9212000U110	110	10	28,40	1	6	B	■

923



wall plate elbow



Ref.	D x G	PFA (PN)	€	pack	box	type	stock
IQ92320F0U25C	25 x 3/4"	10	3,64	10	120	B	■

931



male adaptor  
with brass threaded insert



Ref.	D x G	PFA (PN)	€	pack	box	type	stock
IQ93120M0N20B	20 x 1/2"	16	4,47	20	-	-	■
IQ93120M0N25C	25 x 3/4"	16	5,08	10	-	-	■
IQ93120M0N32D	32 x 1"	16	11,90	10	-	-	■
IQ93120M0N40E	40 x 1" 1/4	16	15,40	5	-	-	■
IQ93120M0N50F	50 x 1" 1/2	16	33,50	5	-	-	■
IQ93120M0N63G	63 x 2"	16	43,30	5	-	-	■

victaulic adaptor

925



Ref.	D x D	PFA (PN)	€	pack	box	type	stock
IQ92520D0U63G	63 x 2"	10	4,94	1	30	B	■
IQ92520D0U75H	75 x 2" 1/2	10	10,72	1	18	B	■
IQ92520D0U75I	75 x 3"	10	10,72	1	15	B	■
IQ92520D0U90I	90 x 3"	10	17,03	1	12	B	■
IQ92520D0U90L	90 x 4"	10	17,03	1	10	B	■
IQ92520D0U11L	110 x 4"	10	27,39	1	6	J	■

932



female adaptor  
with brass threaded insert



Ref.	D x G	PFA (PN)	€	pack	box	type	stock
IQ93220F0N20B	20 x 1/2"	16	3,95	20	-	-	■
IQ93220F0N25C	25 x 3/4"	16	4,60	10	-	-	■
IQ93220F0N32D	32 x 1"	16	9,10	10	-	-	■
IQ93220F0N40E	40 x 1" 1/4	16	15,50	5	-	-	■
IQ93220F0N50F	50 x 1" 1/2	16	30,70	5	-	-	■
IQ93220F0N63G	63 x 2"	16	39,10	5	-	-	■

90° elbow  
with brass threaded insert

935



Ref.	D x G	PFA (PN)	€	pack	box	type	stock
IQ93520M0N20B	20 x 1/2"	16	4,75	20	-	-	■
IQ93520M0N20C	20 x 3/4"	16	5,60	20	-	-	■
IQ93520M0N25C	25 x 3/4"	16	5,80	10	-	-	■
IQ93520M0N32D	32 x 1"	16	16,20	10	-	-	■
IQ93520M0N40E	40 x 1" 1/4	16	28,60	5	-	-	■
IQ93520M0N50F	50 x 1" 1/2	16	31,80	5	-	-	■
IQ93520M0N63G	63 x 2"	16	49,10	5	-	-	■

\* With stainless steel reinforcing ring

• NPT thread available

clinching ring



Ref.	D	PFA (PN)	€	pack	box	type	stock
0Q9AG6000B016	16	-	<b>0,16</b>	1	-	-	
0Q2AG6000B020	20	-	<b>0,22</b>	1	-	-	
0Q2AG6000B025	25	-	<b>0,26</b>	1	-	-	
0Q2AG6000B032	32	-	<b>0,34</b>	1	-	-	
0Q9AG6000B040	40	-	<b>0,55</b>	1	-	-	
0Q9AG6000B050	50	-	<b>0,75</b>	1	-	-	
0Q9AG6000B063	63	-	<b>1,05</b>	1	-	-	
0Q2AG6000B075	75	-	<b>1,96</b>	1	-	-	
0Q2AG6000B090	90	-	<b>2,42</b>	1	-	-	
0Q2AG6000B110	110	-	<b>5,18</b>	1	-	-	



nut



Ref.	D	PFA (PN)	€	pack	box	type	stock
0Q2GH2000U160	16	-	<b>0,24</b>	1	-	-	
0Q9GH2000U020	20	-	<b>0,37</b>	1	-	-	
0Q9GH2000U025	25	-	<b>0,45</b>	1	-	-	
0Q9GH2000U032	32	-	<b>0,58</b>	1	-	-	
0Q9GH2000U040	40	-	<b>0,94</b>	1	-	-	
0Q9GH2000U050	50	-	<b>1,28</b>	1	-	-	
0Q9GH2000U063	63	-	<b>1,78</b>	1	-	-	
0Q9GH2000U075	75	-	<b>3,35</b>	1	-	-	
0Q9GH2000U090	90	-	<b>4,15</b>	1	-	-	
0Q9GH2000U110	110	-	<b>8,87</b>	1	-	-	



o-ring



Ref.	D	PFA (PN)	€	pack	box	type	stock
0HOR1500300A0	16	-	<b>0,15</b>	10	-	-	
0HOR1800300A0	20	-	<b>0,20</b>	10	-	-	
0HOR2280400A0	25	-	<b>0,24</b>	10	-	-	
0HOR2940450A0	32	-	<b>0,31</b>	10	-	-	
0HOR3700500A0	40	-	<b>0,51</b>	10	-	-	
0HOR4860535A0	50	-	<b>0,69</b>	10	-	-	
0HOR6100600A0	63	-	<b>0,96</b>	10	-	-	
0HOR7700800A0	75	-	<b>1,82</b>	5	-	-	
0HOR920010A0	90	-	<b>2,25</b>	5	-	-	
0HOR1120010A0	110	-	<b>4,81</b>	5	-	-	



blocking bush



Ref.	D	PFA (PN)	€	pack	box	type	stock
0Q9DS2000N016	16	-	<b>0,14</b>	10	-	-	
0Q2DS2000N020	20	-	<b>0,19</b>	10	-	-	
0Q2DS2000N025	25	-	<b>0,22</b>	10	-	-	
0Q2DS2000N032	32	-	<b>0,29</b>	10	-	-	
0Q2DS2000N040	40	-	<b>0,47</b>	10	-	-	
0Q2DS2000N050	50	-	<b>0,64</b>	10	-	-	
0Q2DS2000N063	63	-	<b>0,89</b>	10	-	-	
0Q2DS2000N075	75	-	<b>1,68</b>	5	-	-	
0Q2DS2000N090	90	-	<b>2,07</b>	5	-	-	
0Q2DS2000N110	110	-	<b>4,44</b>	5	-	-	



clamping wrench



Ref.	D	PFA (PN)	€	pack	box	type	stock
IICSE2000R500	25 - 63	-	<b>20,84</b>	1	-	-	
IICSE2000R750	25 - 110	-	<b>23,82</b>	1	-	-	



female adaptor

male adaptor

201



Ref.	D x G	PFA (PN)	€	pack	box	type	stock
• IQ20120F0N16B	16 x 1/2"	12,5	<b>0,66</b>	20	340	C	■
• IQ20120F0N16C	16 x 3/4"	12,5	<b>0,66</b>	20	280	C	■
• IQ20120F0N20B	20 x 1/2"	12,5	<b>0,88</b>	20	240	C	■
• IQ20120F0N20C	20 x 3/4"	12,5	<b>0,88</b>	20	220	C	■
• IQ20120F0N20D	20 x 1"	12,5	<b>0,88</b>	20	200	B	■
• IQ20120F0N25B	25 x 1/2"	12,5	<b>1,02</b>	10	300	B	■
• IQ20120F0N25C	25 x 3/4"	12,5	<b>1,02</b>	10	300	B	■
• IQ20120F0N25D	25 x 1"	12,5	<b>1,02</b>	10	300	B	■
• IQ20120F0N32B	32 x 1/2"	12,5	<b>1,30</b>	10	200	B	■
• IQ20120F0N32C	32 x 3/4"	12,5	<b>1,30</b>	10	200	B	■
• IQ20120F0N32D	32 x 1"	12,5	<b>1,30</b>	10	180	B	■
• IQ20120F0N32E	32 x 1" 1/4	10	<b>1,80</b>	10	160	B	■
• IQ20120F0N40D	40 x 1"	10	<b>2,23</b>	5	100	B	■
• IQ20120F0N40E	40 x 1" 1/4	10	<b>2,23</b>	5	100	B	■
• IQ20120F0N40F	40 x 1" 1/2	10	<b>2,32</b>	5	100	B	■
• IQ20120F0N40G	40 x 2"	10	<b>2,32</b>	5	80	B	■
• IQ20120F0N50E	50 x 1" 1/4	10	<b>2,90</b>	5	65	B	■
• IQ20120F0N50F	50 x 1" 1/2	10	<b>2,90</b>	5	65	B	■
• IQ20120F0N50G	50 x 2**	10	<b>3,10</b>	5	60	B	■
• IQ20120F0N63E	63 x 1" 1/4	10	<b>4,10</b>	5	35	B	■
• IQ20120F0N63F	63 x 1" 1/2	10	<b>4,10</b>	5	35	B	■
• IQ20120F0N63G	63 x 2**	10	<b>4,10</b>	5	35	B	■
• IQ20120F0N75G	75 x 2**	10	<b>8,70</b>	1	18	B	■
• IQ20120F0N75H	75 x 2" 1/2*	10	<b>8,70</b>	1	15	B	■
• IQ20120F0N90H	90 x 2" 1/2*	10	<b>10,80</b>	1	12	B	■
• IQ20120F0N90I	90 x 3**	10	<b>10,80</b>	1	12	B	■
• IQ20120F0N11I	110 x 3**	10	<b>25,50</b>	1	6	B	■
• IQ20120F0N11L	110 x 4**	10	<b>25,50</b>	1	6	B	■

211



Ref.	D x G	PFA (PN)	€	pack	box	type	stock
• IQ21120M0N16B	16 x 1/2"	12,5	<b>0,68</b>	20	400	C	■
• IQ21120M0N16C	16 x 3/4"	12,5	<b>0,68</b>	20	400	C	■
• IQ21120M0N20B	20 x 1/2"	12,5	<b>0,81</b>	20	240	C	■
• IQ21120M0N20C	20 x 3/4"	12,5	<b>0,81</b>	20	240	C	■
• IQ21120M0N20D	20 x 1"	12,5	<b>0,81</b>	20	200	-	■
• IQ21120M0N25B	25 x 1/2"	12,5	<b>0,93</b>	10	300	B	■
• IQ21120M0N25C	25 x 3/4"	12,5	<b>0,93</b>	10	300	B	■
• IQ21120M0N25D	25 x 1"	12,5	<b>0,93</b>	10	300	B	■
• IQ21120M0N32C	32 x 3/4"	12,5	<b>1,18</b>	10	180	B	■
• IQ21120M0N32D	32 x 1"	12,5	<b>1,18</b>	10	180	B	■
• IQ21120M0N32E	32 x 1" 1/4	10	<b>1,32</b>	10	180	B	■
• IQ21120M0N40D	40 x 1"	10	<b>2,19</b>	5	100	B	■
• IQ21120M0N40E	40 x 1" 1/4	10	<b>2,19</b>	5	100	B	■
• IQ21120M0N40F	40 x 1" 1/2	10	<b>2,19</b>	5	100	B	■
• IQ21120M0N50E	50 x 1" 1/4	10	<b>2,94</b>	5	70	B	■
• IQ21120M0N50F	50 x 1" 1/2	10	<b>2,94</b>	5	70	B	■
• IQ21120M0N50G	50 x 2**	10	<b>3,00</b>	5	60	B	■
• IQ21120M0N63F	63 x 1" 1/2	10	<b>4,07</b>	5	40	B	■
• IQ21120M0N63G	63 x 2**	10	<b>4,07</b>	5	40	B	■
• IQ21120M0N63H	63 x 2" 1/2	10	<b>4,07</b>	5	35	B	■
• IQ21120M0N75G	75 x 2**	10	<b>8,60</b>	1	18	B	■
• IQ21120M0N75H	75 x 2" 1/2*	10	<b>8,60</b>	1	18	B	■
• IQ21120M0N75I	75 x 3**	10	<b>8,95</b>	1	15	B	■
• IQ21120M0N90G	90 x 2"	10	<b>10,20</b>	1	12	B	■
• IQ21120M0N90H	90 x 2" 1/2*	10	<b>10,20</b>	1	12	B	■
• IQ21120M0N90I	90 x 3**	10	<b>10,20</b>	1	12	B	■
• IQ21120M0N90L	90 x 4**	10	<b>11,00</b>	1	12	B	■
• IQ21120M0N11I	110 x 3**	10	<b>19,90</b>	1	6	B	■
• IQ21120M0N11L	110 x 4**	10	<b>19,90</b>	1	6	B	■

coupling

reducer coupling

210



Ref.	D x D	PFA (PN)	€	pack	box	type	stock
IQ2102000N160	16 x 16	12,5	<b>1,02</b>	20	240	C	■
IQ2102000N200	20 x 20	12,5	<b>1,32</b>	20	160	C	■
IQ2102000N250	25 x 25	12,5	<b>1,68</b>	10	200	B	■
IQ2102000N320	32 x 32	12,5	<b>2,16</b>	10	120	B	■
IQ2102000N400	40 x 40	10	<b>3,53</b>	5	65	B	■
IQ2102000N500	50 x 50	10	<b>4,81</b>	5	40	B	■
IQ2102000N630	63 x 63	10	<b>6,67</b>	5	25	B	■
IQ2102000N750	75 x 75	10	<b>13,30</b>	1	10	B	■
IQ2102000N900	90 x 90	10	<b>16,70</b>	1	7	B	■
IQ2102000N110	110 x 110	10	<b>35,00</b>	1	6	J	■

212



Ref.	D x D	PFA (PN)	€	pack	box	type	stock
IQ2122000N20A	20 x 16	12,5	<b>1,40</b>	20	200	C	■
IQ2122000N25A	25 x 16	12,5	<b>1,52</b>	10	240	B	■
IQ2122000N25B	25 x 20	12,5	<b>1,52</b>	10	240	B	■
IQ2122000N32B	32 x 20	12,5	<b>1,99</b>	10	140	B	■
IQ2122000N32C	32 x 25	12,5	<b>1,99</b>	10	140	B	■
IQ2122000N40C	40 x 25	10	<b>3,43</b>	5	100	B	■
IQ2122000N40D	40 x 32	10	<b>3,43</b>	5	90	B	■
IQ2122000N50C	50 x 25	10	<b>4,44</b>	5	65	B	■
IQ2122000N50D	50 x 32	10	<b>4,44</b>	5	55	B	■
IQ2122000N50E	50 x 40	10	<b>4,44</b>	5	50	B	■
IQ2122000N63D	63 x 32	10	<b>6,30</b>	5	30	B	■
IQ2122000N63E	63 x 40	10	<b>6,30</b>	5	30	B	■
IQ2122000N63F	63 x 50	10	<b>6,30</b>	5	30	B	■
IQ2122000N75F	75 x 50	10	<b>12,10</b>	1	15	B	■
IQ2122000N75G	75 x 63	10	<b>12,10</b>	1	15	B	■
IQ2122000N90G	90 x 63	10	<b>16,00</b>	1	10	B	■
IQ2122000N90H	90 x 75	10	<b>16,70</b>	1	8	B	■
IQ2122000N11I	110 x 90	10	<b>33,50</b>	1	6	J	■

end plug

221



Ref.	D	PFA (PN)	€	pack	box	type	stock
IQ2212000N160	16	12,5	<b>0,75</b>	20	500	C	■
IQ2212000N200	20	12,5	<b>0,95</b>	20	300	C	■
IQ2212000N250	25	12,5	<b>1,05</b>	10	400	B	■
IQ2212000N320	32	12,5	<b>1,29</b>	10	220	B	■
IQ2212000N400	40	10	<b>2,17</b>	5	100	B	■
IQ2212000N500	50	10	<b>3,21</b>	5	80	B	■
IQ2212000N630	63	10	<b>4,35</b>	5	45	B	■
IQ2212000N750	75	10	<b>11,80</b>	1	20	B	■
IQ2212000N900	90	10	<b>13,20</b>	1	12	B	■
IQ2212000N110	110	10	<b>27,00</b>	1	6	B	■

\* With stainless steel reinforcing ring

• NPT thread available

214



90° tee



Ref.	D x D x D	PFA (PN)	€	pack	box	type	stock
IQ2142000N160	16 x 16 x 16	10	1,35	20	140	C	■
IQ2142000N200	20 x 20 x 20	10	1,83	20	80	C	■
IQ2142000N250	25 x 25 x 25	10	2,43	10	100	B	■
IQ2142000N320	32 x 32 x 32	10	3,14	10	60	B	■
IQ2142000N400	40 x 40 x 40	10	5,19	5	40	B	■
IQ2142000N500	50 x 50 x 50	10	7,08	5	20	B	■
IQ2142000N630	63 x 63 x 63	10	10,10	4	12	B	■
IQ2142000N750	75 x 75 x 75	10	18,90	1	5	B	■
IQ2142000N900	90 x 90 x 90	10	26,00	1	3	B	■
IQ2142000N110	110 x 110 x 110	10	49,60	1	2	J	■

216



90° tee  
with male threaded offtake



Ref.	D x G x D	PFA (PN)	€	pack	box	type	stock
• IQ21620M0N16B	16 x 1/2" x 16	10	1,48	20	200	C	■
• IQ21620M0N16C	16 x 3/4" x 16	10	1,48	20	180	C	■
• IQ21620M0N20B	20 x 1/2" x 20	12,5	1,55	20	100	C	■
• IQ21620M0N20C	20 x 3/4" x 20	10	1,55	20	100	C	■
• IQ21620M0N25B	25 x 1/2" x 25	12,5	2,02	10	150	B	■
• IQ21620M0N25C	25 x 3/4" x 25	12,5	2,02	10	120	B	■
• IQ21620M0N25D	25 x 1" x 25	10	2,02	10	120	B	■
• IQ21620M0N32C	32 x 3/4" x 32	10	2,54	10	80	B	■
• IQ21620M0N32D	32 x 1" x 32	10	2,54	10	80	B	■
• IQ21620M0N32E	32 x 1" 1/4 x 32	10	2,54	10	60	B	■
• IQ21620M0N40E	40 x 1" 1/4 x 40	10	4,44	5	45	B	■
• IQ21620M0N40F	40 x 1" 1/2 x 40	10	4,44	5	45	B	■
• IQ21620M0N50E	50 x 1" 1/4 x 50	10	6,30	5	25	-	■
• IQ21620M0N50F	50 x 1" 1/2 x 50	10	6,30	5	25	B	■
• IQ21620M0N50G	50 x 2" x 50	10	6,30	5	25	B	■
• IQ21620M0N63G	63 x 2" x 63	10	12,30	4	12	B	■
• IQ21620M0N75H	75 x 2" 1/2 x 75	10	16,10	1	8	B	■
• IQ21620M0N75I	75 x 3" x 75	10	16,10	1	7	B	■
• IQ21620M0N90I	90 x 3" x 90	10	23,30	1	4	B	■
• IQ21620M0N90L	90 x 4" x 90	10	23,30	1	4	B	■
• IQ21620M0N11L	110 x 4" x 110	10	37,90	1	2	B	■

215



90° tee  
with male threaded offtake



Ref.	D x G x D	PFA (PN)	€	pack	box	type	stock
• IQ21520F0N16B	16 x 1/2" x 16	10	1,16	20	160	C	■
• IQ21520F0N16C	16 x 3/4" x 16	10	1,16	20	160	C	■
• IQ21520F0N20B	20 x 1/2" x 20	12,5	1,47	20	100	C	■
• IQ21520F0N20C	20 x 3/4" x 20	10	1,47	20	100	C	■
• IQ21520F0N25B	25 x 1/2" x 25	10	1,87	10	150	C	■
• IQ21520F0N25C	25 x 3/4" x 25	10	1,87	10	130	C	■
• IQ21520F0N25D	25 x 1" x 25	10	2,08	10	130	C	■
• IQ21520F0N32B	32 x 1/2" x 32	10	2,43	10	80	-	■
• IQ21520F0N32C	32 x 3/4" x 32	10	2,43	10	80	B	■
• IQ21520F0N32D	32 x 1" x 32	10	2,43	10	70	B	■
• IQ21520F0N32E	32 x 1" 1/4 x 32	10	2,49	10	60	B	■
• IQ21520F0N40D	40 x 1 x 40	10	4,45	5	45	B	■
• IQ21520F0N40E	40 x 1" 1/4 x 40	10	4,45	5	45	B	■
• IQ21520F0N40F	40 x 1" 1/2 x 40	10	4,45	5	45	B	■
• IQ21520F0N50E	50 x 1" 1/4 x 50	10	6,05	5	25	B	■
• IQ21520F0N50F	50 x 1" 1/2 x 50	10	6,05	5	25	B	■
• IQ21520F0N50G	50 x 2" x 50*	10	6,40	5	25	B	■
• IQ21520F0N63F	63 x 1" 1/2 x 63	10	8,90	4	12	B	■
• IQ21520F0N63G	63 x 2" x 63*	10	8,90	4	12	B	■
• IQ21520F0N75G	75 x 2" x 75*	10	16,00	1	7	B	■
• IQ21520F0N75H	75 x 2" 1/2 x 75*	10	16,00	1	7	B	■
• IQ21520F0N75I	75 x 3" x 75*	10	16,00	1	7	B	■
• IQ21520F0N90I	90 x 3" x 90*	10	23,80	1	4	B	■
• IQ21520F0N90L	90 x 4" x 90*	10	23,80	1	4	B	■
• IQ21520F0N11L	110 x 4" x 110*	10	36,00	1	2	B	■

224



enlarged 90° tee



Ref.	D x D x D	PFA (PN)	€	pack	box	type	stock
IQ2242000N20A	20 x 16 x 20	10	2,16	20	80	C	■
IQ2242000N20C	20 x 25 x 20	10	2,50	10	120	B	■
IQ2242000N25B	25 x 20 x 25	10	2,50	10	120	B	■
IQ2242000N25D	25 x 32 x 25	10	3,34	10	80	B	■
IQ2242000N32C	32 x 25 x 32	10	3,34	10	70	B	■
IQ2242000N40D	40 x 32 x 40	10	4,64	5	45	B	■
IQ2242000N50D	50 x 32 x 50	10	6,37	5	20	-	■
IQ2242000N50E	50 x 40 x 50	10	6,37	5	20	B	■
IQ2242000N63F	63 x 50 x 63	10	8,32	4	12	B	■
IQ2242000N75G	75 x 63 x 75	10	15,80	1	5	B	■

\* With stainless steel reinforcing ring

• NPT thread available

90° elbow

213



irritec

Ref.	D x D	PFA (PN)	€	pack	box	type	stock
IQ2132000N160	16 x 16	10	1,10	20	240	C	■
IQ2132000N200	20 x 20	10	1,40	20	140	C	■
IQ2132000N250	25 x 25	10	1,71	10	180	B	■
IQ2132000N320	32 x 32	10	2,13	10	100	B	■
IQ2132000N400	40 x 40	10	3,75	5	60	B	■
IQ2132000N500	50 x 50	10	5,19	5	35	B	■
IQ2132000N630	63 x 63	10	6,65	5	20	B	■
IQ2132000N750	75 x 75	10	13,80	1	8	B	■
IQ2132000N900	90 x 90	10	17,10	1	5	B	■
IQ2132000N110	110 x 110	10	33,50	1	4	J	■

90° elbow with female threaded offtake

218



irritec

Ref.	D x G	PFA (PN)	€	pack	box	type	stock
• IQ21820F0N16B	16 x 1/2"	10	0,85	20	300	C	■
• IQ21820F0N16C	16 x 3/4"	10	0,85	20	240	C	■
• IQ21820F0N20B	20 x 1/2"	12,5	1,05	20	200	C	■
• IQ21820F0N20C	20 x 3/4"	10	1,05	20	160	C	■
• IQ21820F0N25B	25 x 1/2"	10	1,32	10	240	B	■
• IQ21820F0N25C	25 x 3/4"	10	1,32	10	240	B	■
• IQ21820F0N25D	25 x 1"	10	1,32	10	200	B	■
• IQ21820F0N32B	32 x 1/2"	10	1,55	10	160	-	■
• IQ21820F0N32C	32 x 3/4"	10	1,55	10	160	B	■
• IQ21820F0N32D	32 x 1"	10	1,55	10	160	B	■
• IQ21820F0N32E	32 x 1 1/4"	10	1,55	10	110	B	■
• IQ21820F0N40C	40 x 3/4"	10	3,06	5	80	-	■
• IQ21820F0N40D	40 x 1"	10	3,06	5	80	B	■
• IQ21820F0N40E	40 x 1 1/4"	10	3,06	5	80	B	■
• IQ21820F0N40F	40 x 1 1/2"	10	3,06	5	80	B	■
• IQ21820F0N50F	50 x 1 1/2"	10	4,08	5	50	B	■
• IQ21820F0N50G	50 x 2"	10	4,08	5	45	B	■
• IQ21820F0N63F	63 x 1 1/2"	10	5,60	5	25	B	■
• IQ21820F0N63G	63 x 2"	10	5,60	5	25	B	■
• IQ21820F0N75H	75 x 2 1/2"	10	10,70	1	12	B	■
• IQ21820F0N75I	75 x 3"	10	10,70	1	12	B	■
• IQ21820F0N90I	90 x 3"	10	19,70	1	8	B	■
• IQ21820F0N90L	90 x 4"	10	19,70	1	8	B	■
• IQ21820F0N11L	110 x 4"	10	32,00	1	6	J	■

90° elbow with male threaded offtake

219



irritec

Ref.	D x G	PFA (PN)	€	pack	box	type	stock
• IQ21920M0N16B	16 x 1/2"	10	0,89	20	360	C	■
• IQ21920M0N16C	16 x 3/4"	10	0,89	20	320	C	■
• IQ21920M0N20B	20 x 1/2"	12,5	0,94	20	240	C	■
• IQ21920M0N20C	20 x 3/4"	10	0,94	20	200	C	■
• IQ21920M0N25B	25 x 1/2"	12,5	1,14	10	250	B	■
• IQ21920M0N25C	25 x 3/4"	12,5	1,14	10	250	B	■
• IQ21920M0N25D	25 x 1"	10	1,14	10	240	B	■
• IQ21920M0N32C	32 x 3/4"	12,5	1,47	10	160	B	■
• IQ21920M0N32D	32 x 1"	12,5	1,47	10	160	B	■
• IQ21920M0N32E	32 x 1 1/4"	10	1,47	10	140	B	■
• IQ21920M0N40D	40 x 1"	10	2,35	5	80	-	■
• IQ21920M0N40E	40 x 1 1/4"	10	2,35	5	80	B	■
• IQ21920M0N40F	40 x 1 1/2"	10	2,35	5	80	B	■
• IQ21920M0N50F	50 x 1 1/2"	10	3,20	5	50	B	■
• IQ21920M0N50G	50 x 2"	10	3,20	5	45	B	■
• IQ21920M0N63G	63 x 2"	10	4,45	5	25	B	■
• IQ21920M0N63H	63 x 2 1/2"	10	4,45	5	25	B	■
• IQ21920M0N75H	75 x 2 1/2"	10	10,00	1	14	B	■
• IQ21920M0N75I	75 x 3"	10	10,00	1	12	B	■
• IQ21920M0N90I	90 x 3"	10	13,30	1	8	B	■
• IQ21920M0N90L	90 x 4"	10	13,70	1	8	B	■
• IQ21920M0N11L	110 x 4"	10	24,50	1	6	J	■

90° elbow for pop-up

222



irritec

Ref.	D x D x G	PFA (PN)	€	pack	box	type	stock
• IQ22220F0N25B	25 x 25 x 1/2"	10	2,17	10	160	B	■
• IQ22220F0N32C	32 x 32 x 3/4"	10	2,65	10	100	B	■

wall plate elbow

223



irritec

Ref.	D x G	PFA (PN)	€	pack	box	type	stock
IQ22320F0N25C	25 x 3/4"	10	3,23	10	120	B	■

\* With stainless steel reinforcing ring      • NPT thread available

clinching ring

2AG



Ref.	D	PFA (PN)	€	pack	box	type	stock
0Q9AG6000B016	16	-	0,16	1	-	-	
0Q2AG6000B020	20	-	0,22	1	-	-	
0Q2AG6000B025	25	-	0,26	1	-	-	
0Q2AG6000B032	32	-	0,34	1	-	-	
0Q9AG6000B040	40	-	0,55	1	-	-	
0Q9AG6000B050	50	-	0,75	1	-	-	
0Q9AG6000B063	63	-	1,04	1	-	-	
0Q2AG6000B075	75	-	1,96	1	-	-	
0Q2AG6000B090	90	-	2,42	1	-	-	
0Q2AG6000B110	110	-	5,18	1	-	-	

nut

2GH



Ref.	D	PFA (PN)	€	pack	box	type	stock
0Q2GH2000V160	16	-	0,24	1	-	-	
0Q2GH2000V020	20	-	0,35	1	-	-	
0Q2GH2000V025	25	-	0,41	1	-	-	
0Q2GH2000V032	32	-	0,54	1	-	-	
0Q2GH2000V040	40	-	0,88	1	-	-	
0Q2GH2000V050	50	-	1,18	1	-	-	
0Q2GH2000V063	63	-	1,65	1	-	-	
0Q2GH2000V075	75	-	3,11	1	-	-	
0Q2GH2000V090	90	-	3,85	1	-	-	
0Q2GH2000V110	110	-	8,25	1	-	-	

o-ring

OR



Ref.	D	PFA (PN)	€	pack	box	type	stock
0HOR1500300A0	16	-	0,15	10	-	-	
0HOR1800300A0	20	-	0,20	10	-	-	
0HOR2280400A0	25	-	0,24	10	-	-	
0HOR2940450A0	32	-	0,31	10	-	-	
0HOR3700500A0	40	-	0,51	10	-	-	
0HOR4860535A0	50	-	0,69	10	-	-	
0HOR6100600A0	63	-	0,96	10	-	-	
0HOR7700800A0	75	-	1,82	5	-	-	
0HOR920010A0	90	-	2,25	5	-	-	
0HOR1120010A0	110	-	5,18	5	-	-	

blocking bush

2DS



Ref.	D	PFA (PN)	€	pack	box	type	stock
0Q9DS2000N016	16	-	0,14	10	-	-	
0Q2DS2000N020	20	-	0,19	10	-	-	
0Q2DS2000N025	25	-	0,22	10	-	-	
0Q2DS2000N032	32	-	0,29	10	-	-	
0Q2DS2000N040	40	-	0,47	10	-	-	
0Q2DS2000N050	50	-	0,64	10	-	-	
0Q2DS2000N063	63	-	0,89	10	-	-	
0Q2DS2000N075	75	-	1,68	5	-	-	
0Q2DS2000N090	90	-	2,07	5	-	-	
0Q2DS2000N110	110	-	4,44	5	-	-	

clamping wrench

CSE



Ref.	D	PFA (PN)	€	pack	box	type	stock
IICSE2000R500	25 - 63	-	20,84	1	-	-	
IICSE2000R750	25 - 110	-	23,82	1	-	-	

single clamp saddle with reinforcing ring

105



Ref.	bolts	D x G	PFA (PN)	€	pack	box	type	stock	Ref.	bolts	D x G	PFA (PN)	€	pack	box	type	stock	
• IS10520F0N20B	2	20 x 1/2"	16	1,38	1	150	C		• IS1052AF0N13H	4	125 x 2" 1/2	6	15,30	1	20	B		
• IS10520F0N25B	2	25 x 1/2"	16	1,38	1	130	C		IS1052AF0N15D	6	140 x 1"	10	12,05	1	20	B		
• IS10520F0N25C	2	25 x 3/4"	16	1,38	1	130	C		IS1052AF0N15E	6	140 x 1" 1/4	10	12,05	1	20	B		
• IS10520F0N32B	2	32 x 1/2"	16	1,50	1	90	C		IS1052AF0N15F	6	140 x 1" 1/2	10	12,95	1	18	B		
• IS10520F0N32C	2	32 x 3/4"	16	1,50	1	90	C		IS1052AF0N15G	6	140 x 2"	10	15,70	1	20	B		
• IS10520F0N32D	2	32 x 1"	16	1,50	1	70	C		IS1052AF0N15H	6	140 x 2" 1/2	6	16,20	1	20	B		
• IS10520F0N40B	2	40 x 1/2"	16	1,74	1	70	C		IS1052AF0N15I	6	140 x 3"	6	18,20	1	18	B		
• IS10520F0N40C	2	40 x 3/4"	16	1,74	1	70	C		• IS1052AF0N17D	6	160 x 1"	10	14,95	1	15	B		
• IS10520F0N40D	2	40 x 1"	16	1,74	1	70	C		IS1052AF0N17E	6	160 x 1" 1/4	10	14,95	1	15	B		
• IS10520F0N50B	2	50 x 1/2"	16	1,87	1	60	C		IS1052AF0N17F	6	160 x 1" 1/2	10	14,95	1	15	B		
• IS10520F0N50C	2	50 x 3/4"	16	1,87	1	60	C		• IS1052AF0N17G	6	160 x 2"	10	17,00	1	15	B		
• IS10520F0N50D	2	50 x 1"	16	1,87	1	60	C		IS1052AF0N17H	6	160 x 2" 1/2	6	17,50	1	15	B		
• IS10520F0N63B	4	63 x 1/2"	16	2,41	1	35	C		• IS1052AF0N17I	6	160 x 3"	6	19,70	1	10	B		
• IS10520F0N63C	4	63 x 3/4"	16	2,41	1	35	C		IS1055AF0N21D	6	200 x 1"	6	41,00	1	8	B		
• IS10520F0N63D	4	63 x 1"	16	2,41	1	35	C		IS1055AF0N21E	6	200 x 1" 1/4	6	43,90	1	8	B		
• IS10520F0N63E	4	63 x 1" 1/4	16	2,41	1	35	C		IS1055AF0N21F	6	200 x 1" 1/2	6	43,90	1	8	B		
• IS10520F0N63F	4	63 x 1" 1/2	10	2,56	1	30	C		IS1055AF0N21G	6	200 x 2"	6	43,90	1	8	B		
• IS10520F0N75B	4	75 x 1/2"	16	3,73	1	50	B		IS1055AF0N21H	6	200 x 2" 1/2	6	45,70	1	8	B		
• IS10520F0N75C	4	75 x 3/4"	16	3,73	1	50	B		IS1055AF0N21I	6	200 x 3"	6	45,70	1	8	B		
• IS10520F0N75D	4	75 x 1"	16	3,73	1	50	B		IS1055AF0N21L	6	200 x 4"	6	45,70	1	8	B		
• IS10520F0N75E	4	75 x 1" 1/4	16	3,88	1	50	B		IS1055AF0N23D	6	225 x 1"	6	53,00	1	8	B		
• IS10520F0N75F	4	75 x 1" 1/2	10	3,88	1	40	B		IS1055AF0N23E	6	225 x 1" 1/4	6	53,00	1	8	B		
• IS10520F0N75G	4	75 x 2"	10	4,45	1	40	B		IS1055AF0N23F	6	225 x 1" 1/2	6	53,00	1	8	B		
• IS10520F0N90B	4	90 x 1/2"	16	4,61	1	40	B		IS1055AF0N23G	6	225 x 2"	6	53,00	1	8	B		
• IS10520F0N90C	4	90 x 3/4"	16	4,61	1	40	B		IS1055AF0N23H	6	225 x 2" 1/2	6	53,00	1	8	B		
• IS10520F0N90D	4	90 x 1"	16	4,61	1	40	B		IS1055AF0N23I	6	225 x 3"	6	53,00	1	8	B		
• IS10520F0N90E	4	90 x 1" 1/4	16	4,95	1	40	B		IS1055AF0N23L	6	225 x 4"	6	53,00	1	8	B		
• IS10520F0N90F	4	90 x 1" 1/2	10	4,95	1	40	B		IS1055AF0N26D	6	250 x 1"	6	61,30	1	7	B		
• IS10520F0N90G	4	90 x 2"	10	5,75	1	35	B		IS1055AF0N26E	6	250 x 1" 1/4	6	61,30	1	7	B		
• IS10520F0N11B	4	110 x 1/2"	16	5,41	1	30	B		IS1055AF0N26F	6	250 x 1" 1/2	6	61,30	1	7	B		
• IS10520F0N11C	4	110 x 3/4"	16	5,41	1	30	B		IS1055AF0N26G	6	250 x 2"	6	61,30	1	7	B		
• IS10520F0N11D	4	110 x 1"	16	5,41	1	30	B		IS1055AF0N26H	6	250 x 2" 1/2	6	64,30	1	7	B		
• IS10520F0N11E	4	110 x 1" 1/4	16	5,41	1	30	B		IS1055AF0N26I	6	250 x 3"	6	64,30	1	5	B		
• IS10520F0N11F	4	110 x 1" 1/2	10	5,41	1	30	B		IS1055AF0N26L	6	250 x 4"	6	64,30	1	5	B		
• IS10520F0N11G	4	110 x 2"	10	6,10	1	30	B		IS1055AF0N33D	6	315 x 1"	6	78,70	1	4	B		
• IS1052AF0N11H	4	110 x 2 1/2"	6	10,45	1	25	B		IS1055AF0N33E	6	315 x 1" 1/4	6	78,70	1	4	B		
• IS1052AF0N11I	4	110 x 3"	6	12,70	1	20	B		IS1055AF0N33F	6	315 x 1" 1/2	6	78,70	1	4	B		
IS1052AF0N13C	4	125 x 3/4"	10	11,35	1	25	B		IS1055AF0N33G	6	315 x 2"	6	78,70	1	4	B		
IS1052AF0N13D	4	125 x 1"	10	11,35	1	25	B		IS1055AF0N33H	6	315 x 2" 1/2	6	78,70	1	4	B		
IS1052AF0N13E	4	125 x 1" 1/4	10	11,35	1	25	B		IS1055AF0N33I	6	315 x 3"	6	78,70	1	4	B		
IS1052AF0N13F	4	125 x 1" 1/2	10	14,45	1	25	B		IS1055AF0N33L	6	315 x 4"	6	78,70	1	4	J		
IS1052AF0N13G	4	125 x 2"	10	14,80	1	25	B											

• NPT thread available



106



double clamp saddle  
with reinforcing ring



Ref.	bolts	D x G x G	PFA (PN)	€	pack	box	type	stock	Ref.	bolts	D x G	PFA (PN)	€	pack	box	type	stock
IS10620F0N20B	2	20 x 1/2" x 1/2"	16	1,65	1	140	-		IS1062AF0N13H	4	125 x 2" 1/2 x 2" 1/2	6	15,40	1	25	-	
IS10620F0N25B	2	25 x 1/2" x 1/2"	16	1,65	1	120	-		IS1062AF0N15D	6	140 x 1" x 1"	10	13,40	1	20	-	
IS10620F0N25C	2	25 x 3/4" x 3/4"	16	1,65	1	100	C		IS1062AF0N15E	6	140 x 1" 1/4 x 1" 1/4	10	13,40	1	20	-	
IS10620F0N32B	2	32 x 1/2" x 1/2"	16	2,05	1	80	C		IS1062AF0N15F	6	140 x 1" 1/2 x 1" 1/2	10	13,40	1	20	-	
IS10620F0N32C	2	32 x 3/4" x 3/4"	16	2,05	1	80	C		IS1062AF0N15G	6	140 x 2" x 2"	10	13,40	1	20	-	
IS10620F0N32D	2	32 x 1" x 1"	16	2,05	1	50	C		IS1062AF0N15H	6	140 x 2" 1/2 x 2" 1/2	6	16,40	1	20	-	
IS10620F0N40B	2	40 x 1/2" x 1/2"	16	2,55	1	60	C		IS1062AF0N15I	6	140 x 3" x 3"	6	16,40	1	20	-	
IS10620F0N40C	2	40 x 3/4" x 3/4"	16	2,55	1	60	C		IS1062AF0N17D	6	160 x 1" x 1"	10	16,40	1	20	-	
IS10620F0N40D	2	40 x 1" x 1"	16	2,55	1	60	C		IS1062AF0N17E	6	160 x 1" 1/4 x 1" 1/4	10	16,40	1	15	-	
IS10620F0N50B	2	50 x 1/2" x 1/2"	16	2,90	1	60	C		IS1062AF0N17F	6	160 x 1" 1/2 x 1" 1/2	10	16,40	1	15	-	
IS10620F0N50C	2	50 x 3/4" x 3/4"	16	2,90	1	60	C		IS1062AF0N17G	6	160 x 2" x 2"	10	16,40	1	15	-	
IS10620F0N50D	2	50 x 1" x 1"	16	2,90	1	50	C		IS1062AF0N17H	6	160 x 2" 1/2 x 2" 1/2	6	21,40	1	15	-	
IS10620F0N63B	4	63 x 1/2" x 1/2"	16	3,45	1	30	C		IS1062AF0N17I	6	160 x 3" x 3"	6	21,40	1	10	-	
IS10620F0N63C	4	63 x 3/4" x 3/4"	16	3,45	1	35	C		IS1065AF0N21D	6	200 x 1" x 1"	6	56,30	1	10	-	
IS10620F0N63D	4	63 x 1" x 1"	16	3,45	1	30	C		IS1065AF0N21E	6	200 x 1" 1/4 x 1" 1/4	6	56,30	1	8	-	
IS10620F0N63E	4	63 x 1" 1/4 x 1" 1/4	16	3,45	1	30	C		IS1065AF0N21F	6	200 x 1" 1/2 x 1" 1/2	6	56,30	1	8	-	
IS10620F0N63F	4	63 x 1" 1/2 x 1" 1/2	10	3,45	1	30	C		IS1065AF0N21G	6	200 x 2" x 2"	6	56,30	1	8	-	
IS10620F0N75B	4	75 x 1/2" x 1/2"	16	3,45	1	50	-		IS1065AF0N21H	6	200 x 2" 1/2 x 2" 1/2	6	61,90	1	8	-	
IS10620F0N75C	4	75 x 3/4" x 3/4"	16	4,55	1	50	B		IS1065AF0N21I	6	200 x 3" x 3"	6	61,90	1	8	-	
IS10620F0N75D	4	75 x 1" x 1"	16	4,55	1	50	-		IS1065AF0N21L	6	200 x 4" x 4"	6	61,90	1	8	-	
IS10620F0N75E	4	75 x 1" 1/4 x 1" 1/4	16	4,55	1	45	-		IS1065AF0N23D	6	225 x 1" x 1"	6	67,30	1	8	-	
IS10620F0N75F	4	75 x 1" 1/2 x 1" 1/2	10	4,85	1	45	-		IS1065AF0N23E	6	225 x 1" 1/4 x 1" 1/4	6	67,30	1	8	-	
IS10620F0N75G	4	75 x 2" x 2"	10	4,85	1	45	-		IS1065AF0N23F	6	225 x 1" 1/2 x 1" 1/2	6	67,30	1	8	-	
IS10620F0N90B	4	90 x 1/2" x 1/2"	16	4,80	1	40	B		IS1065AF0N23G	6	225 x 2" x 2"	6	67,30	1	8	-	
IS10620F0N90C	4	90 x 3/4" x 3/4"	16	4,80	1	40	B		IS1065AF0N23H	6	225 x 2" 1/2 x 2" 1/2	6	70,30	1	8	-	
IS10620F0N90D	4	90 x 1" x 1"	16	4,80	1	40	B		IS1065AF0N23I	6	225 x 3" x 3"	6	70,30	1	8	-	
IS10620F0N90E	4	90 x 1" 1/4 x 1" 1/4	16	4,80	1	40	B		IS1065AF0N23L	6	225 x 4" x 4"	6	70,30	1	8	-	
IS10620F0N90F	4	90 x 1" 1/2 x 1" 1/2	10	5,15	1	40	B		IS1065AF0N26D	6	250 x 1" x 1"	6	93,20	1	8	-	
IS10620F0N90G	4	90 x 2" x 2"	10	5,65	1	30	B		IS1065AF0N26E	6	250 x 1" 1/4 x 1" 1/4	6	93,20	1	7	-	
IS10620F0N11B	4	110 x 1/2" x 1/2"	16	6,50	1	35	-		IS1065AF0N26F	6	250 x 1" 1/2 x 1" 1/2	6	93,20	1	7	-	
IS10620F0N11C	4	110 x 3/4" x 3/4"	16	6,50	1	30	-		IS1065AF0N26G	6	250 x 2" x 2"	6	93,20	1	7	-	
IS10620F0N11D	4	110 x 1" x 1"	16	6,50	1	30	-		IS1065AF0N26H	6	250 x 2" 1/2 x 2" 1/2	6	96,30	1	5	-	
IS10620F0N11E	4	110 x 1" 1/4 x 1" 1/4	16	6,50	1	30	-		IS1065AF0N26I	6	250 x 3" x 3"	6	96,30	1	5	-	
IS10620F0N11F	4	110 x 1" 1/2 x 1" 1/2	10	6,90	1	25	-		IS1065AF0N26L	6	250 x 4" x 4"	6	96,30	1	5	-	
IS10620F0N11G	4	110 x 2" x 2"	10	6,90	1	30	-		IS1065AF0N33D	6	315 x 1" x 1"	6	121,40	1	4	-	
IS1062AF0N11H	4	110 x 2" 1/2 x 2" 1/2	6	9,10	1	30	-		IS1065AF0N33E	6	315 x 1" 1/4 x 1" 1/4	6	121,40	1	4	-	
IS1062AF0N11I	4	110 x 3" x 3"	6	16,00	1	25	-		IS1065AF0N33F	6	315 x 1" 1/2 x 1" 1/2	6	121,40	1	4	-	
IS1062AF0N13C	4	125 x 3/4" x 3/4"	10	9,50	1	25	-		IS1065AF0N33G	6	315 x 2" x 2"	6	121,40	1	4	-	
IS1062AF0N13D	4	125 x 1" x 1"	10	9,50	1	25	-		IS1065AF0N33H	6	315 x 2" 1/2 x 2" 1/2	6	128,60	1	4	-	
IS1062AF0N13E	4	125 x 1" 1/4 x 1" 1/4	10	9,50	1	25	-		IS1065AF0N33I	6	315 x 3" x 3"	6	128,60	1	4	-	
IS1062AF0N13F	4	125 x 1" 1/2 x 1" 1/2	10	9,50	1	25	-		IS1065AF0N33L	6	315 x 4" x 4"	6	128,60	1	4	-	
IS1062AF0N13G	4	125 x 2" x 2"	10	9,50	1	25	-										

single clamp saddle

double clamp saddle

103



104



Ref.	bolts	D x G	PFA (PN)	€	pack	box	type	stock
• IS10320F0N20B	2	20 x 1/2"	10	0,82	1	150	C	■
• IS10320F0N25B	2	25 x 1/2"	16	0,82	1	130	C	■
• IS10320F0N25C	2	25 x 3/4"	16	0,82	1	130	C	■
• IS10320F0N32B	2	32 x 1/2"	16	1,02	1	90	C	■
• IS10320F0N32C	2	32 x 3/4"	16	1,02	1	90	C	■
• IS10320F0N32D	2	32 x 1"	16	1,15	1	70	C	■
• IS10320F0N40B	2	40 x 1/2"	16	1,20	1	70	C	■
• IS10320F0N40C	2	40 x 3/4"	16	1,20	1	70	C	■
• IS10320F0N40D	2	40 x 1"	16	1,20	1	70	C	■
• IS10320F0N50B	2	50 x 1/2"	16	1,25	1	60	C	■
• IS10320F0N50C	2	50 x 3/4"	16	1,25	1	60	C	■
• IS10320F0N50D	2	50 x 1"	16	1,25	1	60	C	■
• IS10320F0N63B	4	63 x 1/2"	16	1,76	1	35	C	■
• IS10320F0N63C	4	63 x 3/4"	16	1,76	1	35	C	■
• IS10320F0N63D	4	63 x 1"	16	1,76	1	35	C	■
• IS10320F0N63E	4	63 x 1 1/4"	10	1,90	1	35	C	■
• IS10320F0N63F	4	63 x 1 1/2"	10	1,90	1	30	C	■
• IS10320F0N75B	4	75 x 1/2"	16	3,07	1	50	B	■
• IS10320F0N75C	4	75 x 3/4"	16	3,07	1	50	B	■
• IS10320F0N75D	4	75 x 1"	16	3,07	1	50	B	■
• IS10320F0N75E	4	75 x 1 1/4"	10	3,25	1	50	B	■
• IS10320F0N75F	4	75 x 1 1/2"	10	3,25	1	40	B	■
• IS10320F0N75G	4	75 x 2"	6	3,45	1	40	B	■
• IS10320F0N90B	4	90 x 1/2"	16	3,95	1	40	B	■
• IS10320F0N90C	4	90 x 3/4"	16	3,95	1	40	B	■
• IS10320F0N90D	4	90 x 1"	16	3,95	1	40	B	■
• IS10320F0N90E	4	90 x 1 1/4"	10	4,30	1	40	B	■
• IS10320F0N90F	4	90 x 1 1/2"	10	4,30	1	40	B	■
• IS10320F0N90G	4	90 x 2"	6	4,75	1	35	B	■
• IS10320F0N11B	4	110 x 1/2"	16	4,75	1	30	B	■
• IS10320F0N11C	4	110 x 3/4"	16	4,75	1	30	B	■
• IS10320F0N11D	4	110 x 1"	16	4,75	1	30	B	■
• IS10320F0N11E	4	110 x 1 1/4"	10	4,75	1	30	B	■
• IS10320F0N11F	4	110 x 1 1/2"	10	4,75	1	30	B	■
• IS10320F0N11G	4	110 x 2"	6	5,10	1	30	B	■
• IS1032AF0N11H	4	110 x 2 1/2"	6	8,95	1	30	B	■
IS1032AF0N11I	4	110 x 3"	6	10,70	1	20	B	■
IS1032AF0N13C	4	125 x 3/4"	6	10,70	1	25	B	■
IS1032AF0N13D	4	125 x 1"	6	10,70	1	25	B	■
IS1032AF0N13E	4	125 x 1 1/4"	6	10,70	1	25	B	■
IS1032AF0N13F	4	125 x 1 1/2"	6	13,80	1	25	B	■
IS1032AF0N13G	4	125 x 2"	6	13,80	1	25	B	■
IS1032AF0N13H	4	125 x 2 1/2"	6	13,80	1	20	B	■
IS1032AF0N15D	6	140 x 1"	6	11,40	1	20	B	■
IS1032AF0N15E	6	140 x 1 1/4"	6	11,40	1	20	B	■
IS1032AF0N15F	6	140 x 1 1/2"	6	12,30	1	20	B	■
IS1032AF0N15G	6	140 x 2"	6	14,70	1	20	B	■
IS1032AF0N15H	6	140 x 2 1/2"	6	14,70	1	20	B	■
IS1032AF0N15I	6	140 x 3"	6	16,20	1	20	B	■
• IS1032AF0N17D	6	160 x 1"	6	14,30	1	15	B	■
IS1032AF0N17E	6	160 x 1 1/4"	6	14,30	1	15	B	■
IS1032AF0N17F	6	160 x 1 1/2"	6	14,30	1	15	B	■
• IS1032AF0N17G	6	160 x 2"	6	16,00	1	15	B	■
IS1032AF0N17H	6	160 x 2 1/2"	6	16,00	1	15	B	■
IS1032AF0N17I	6	160 x 3"	6	17,70	1	10	B	■

Ref.	bolts	D x G x G	PFA (PN)	€	pack	box	type	stock
IS10420F0N20B	2	20 x 1/2" x 1/2"	10	1,10	1	140	C	■
IS10420F0N25B	2	25 x 1/2" x 1/2"	10	1,10	1	130	C	■
IS10420F0N25C	2	25 x 3/4" x 3/4"	10	1,10	1	100	C	■
IS10420F0N32B	2	32 x 1/2" x 1/2"	10	1,25	1	80	C	■
IS10420F0N32C	2	32 x 3/4" x 3/4"	10	1,25	1	80	C	■
IS10420F0N32D	2	32 x 1" x 1"	10	1,40	1	50	C	■
IS10420F0N40B	2	40 x 1/2" x 1/2"	10	1,40	1	60	C	■
IS10420F0N40C	2	40 x 3/4" x 3/4"	10	1,40	1	60	C	■
IS10420F0N40D	2	40 x 1" x 1"	10	1,40	1	50	C	■
IS10420F0N50B	2	50 x 1/2" x 1/2"	10	1,46	1	60	C	■
IS10420F0N50C	2	50 x 3/4" x 3/4"	10	1,46	1	60	C	■
IS10420F0N50D	2	50 x 1" x 1"	10	1,46	1	50	C	■
IS10420F0N63B	4	63 x 1/2" x 1/2"	10	2,03	1	30	C	■
IS10420F0N63C	4	63 x 3/4" x 3/4"	10	2,03	1	35	C	■
IS10420F0N63D	4	63 x 1" x 1"	10	2,03	1	30	C	■
IS10420F0N63E	4	63 x 1 1/4" x 1 1/4"	6	2,15	1	25	C	■
IS10420F0N63F	4	63 x 1 1/2" x 1 1/2"	6	2,15	1	25	C	■
IS10420F0N75B	4	75 x 1/2" x 1/2"	10	3,15	1	30	B	■
IS10420F0N75C	4	75 x 3/4" x 3/4"	10	3,15	1	50	B	■
IS10420F0N75D	4	75 x 1" x 1"	10	3,15	1	50	B	■
IS10420F0N75E	4	75 x 1 1/4" x 1 1/4"	6	3,15	1	45	B	■
IS10420F0N75F	4	75 x 1 1/2" x 1 1/2"	6	3,45	1	45	B	■
IS10420F0N75G	4	75 x 2" x 2"	6	3,85	1	35	B	■
IS10420F0N90B	4	90 x 1/2" x 1/2"	10	4,05	1	40	B	■
IS10420F0N90C	4	90 x 3/4" x 3/4"	10	4,05	1	40	B	■
IS10420F0N90D	4	90 x 1" x 1"	10	4,05	1	40	B	■
IS10420F0N90E	4	90 x 1 1/4" x 1 1/4"	6	4,75	1	40	B	■
IS10420F0N90F	4	90 x 1 1/2" x 1 1/2"	6	4,75	1	40	B	■
IS10420F0N90G	4	90 x 2" x 2"	6	5,10	1	30	B	■
IS10420F0N11B	4	110 x 1/2" x 1/2"	10	5,10	1	30	B	■
IS10420F0N11C	4	110 x 3/4" x 3/4"	10	5,10	1	30	B	■
IS10420F0N11D	4	110 x 1" x 1"	10	5,10	1	30	B	■
IS10420F0N11E	4	110 x 1 1/4" x 1 1/4"	6	5,10	1	30	B	■
IS10420F0N11F	4	110 x 1 1/2" x 1 1/2"	6	5,10	1	30	B	■
IS10420F0N11G	4	110 x 2" x 2"	6	5,70	1	25	B	■
IS1042AF0N11H	4	110 x 2 1/2" x 2 1/2"	4	9,30	1	25	B	■
IS1042AF0N11I	4	110 x 3" x 3"	4	10,50	1	20	B	■

• NPT thread available



T11



90° tee

Ref.	D	PFA (PN)	€	pack	box	type	stock
A31RTI116000	16	16	0,72	-	300	-	
A31RTI120000	20	16	0,73	-	400	-	
A31RTI125000	25	16	0,88	-	220	-	
A31RTI132000	32	16	1,31	-	100	-	
A31RTI140000	40	16	2,09	-	70	-	
A31RTI150000	50	16	2,59	-	90	-	
A31RTI163000	63	16	3,98	-	50	-	
A31RTI175000	75	16	7,45	-	32	-	
A31RTI190000	90	16	10,40	-	20	-	
A31RTI111000	110	16	17,60	-	10	-	
A31RTI113000	125	16	33,80	-	7	-	
A31RTI115000	140	16	46,00	-	4	-	
A31RTI117000	160	16	56,10	-	3	-	
A31RTI118000	180	10	100,70	-	-	-	
A31RTI121000	200	10	105,20	-	1	-	
A31RTI123000	225	10	134,60	-	1	-	
A31RTI126000	250	10	359,40	-	1	-	
A31RTI128000	280	10	573,90	-	1	-	
A31RTI133000	315	10	695,00	-	1	-	

G01



90° elbow

Ref.	D	PFA (PN)	€	pack	box	type	stock
A31RGO116000	16	16	0,53	-	350	-	
A31RGO120000	20	16	0,63	-	250	-	
A31RGO125000	25	16	0,69	-	300	-	
A31RGO132000	32	16	0,81	-	180	-	
A31RGO140000	40	16	1,49	-	120	-	
A31RGO150000	50	16	2,13	-	120	-	
A31RGO163000	63	16	2,99	-	60	-	
A31RGO175000	75	16	6,61	-	40	-	
A31RGO190000	90	16	8,99	-	25	-	
A31RGO111000	110	16	13,80	-	14	-	
A31RGO113000	125	16	26,10	-	10	-	
A31RGO115000	140	16	31,10	-	6	-	
A31RGO117000	160	16	47,40	-	4	-	
A31RGO118000	180	10	91,30	-	-	-	
A31RGO121000	200	10	97,30	-	1	-	
A31RGO123000	225	10	120,80	-	1	-	
A31RGO126000	250	10	342,90	-	1	-	
A31RGO128000	280	10	536,10	-	1	-	
A31RGO133000	315	10	607,70	-	1	-	

GY1



45° elbow

Ref.	D	PFA (PN)	€	pack	box	type	stock
A31RGY116000	16	16	1,01	-	500	-	
A31RGY120000	20	16	1,04	-	300	-	
A31RGY125000	25	16	1,30	-	400	-	
A31RGY132000	32	16	1,42	-	200	-	
A31RGY140000	40	16	1,83	-	150	-	
A31RGY150000	50	16	2,66	-	150	-	
A31RGY163000	63	16	3,45	-	90	-	
A31RGY175000	75	16	5,96	-	50	-	
A31RGY190000	90	16	8,12	-	30	-	
A31RGY111000	110	16	17,50	-	16	-	
A31RGY113000	125	16	22,90	-	12	-	
A31RGY115000	140	16	31,20	-	6	-	
A31RGY117000	160	16	36,80	-	6	-	
A31RGY121000	200	10	83,30	-	2	-	
A31RGY123000	225	10	89,90	-	1	-	
A31RGY126000	250	10	277,30	-	1	-	
A31RGY128000	280	10	418,00	-	1	-	
A31RGY133000	315	10	557,30	-	1	-	

MA1



coupling

Ref.	D	PFA (PN)	€	pack	box	type	stock
A31RMA116000	16	16	0,51	-	600	-	
A31RMA120000	20	16	0,51	-	350	-	
A31RMA125000	25	16	0,58	-	400	-	
A31RMA132000	32	16	0,63	-	250	-	
A31RMA140000	40	16	1,01	-	180	-	
A31RMA150000	50	16	1,31	-	200	-	
A31RMA163000	63	16	1,85	-	100	-	
A31RMA175000	75	16	4,20	-	80	-	
A31RMA190000	90	16	6,55	-	45	-	
A31RMA111000	110	16	9,19	-	27	-	
A31RMA113000	125	16	13,70	-	20	-	
A31RMA115000	140	16	17,90	-	12	-	
A31RMA117000	160	16	21,50	-	6	-	
A31RMA121000	200	10	52,60	-	3	-	
A31RMA123000	225	10	61,90	-	3	-	

CR1



cross

Ref.	D	PFA (PN)	€	pack	box	type	stock
A31RCR125000	25	16	2,56	-	100	-	
A31RCR132000	32	16	2,95	-	100	-	
A31RCR140000	40	16	4,51	-	60	-	
A31RCR150000	50	16	5,64	-	35	-	
A31RCR163000	63	16	7,90	-	20	-	

MR1



reduced socket

Ref.	D x D	PFA (PN)	€	pack	box	type	stock
A31RMR120A00	20 x 16	16	0,66	-	500	-	
A31RMR125B00	25 x 20	16	0,71	-	300	-	
A31RMR132C00	32 x 25	16	0,91	-	170	-	
A31RMR140D00	40 x 32	16	1,20	-	200	-	
A31RMR150E00	50 x 40	16	1,43	-	120	-	
A31RMR163F00	63 x 50	16	2,26	-	80	-	
A31RMR175G00	75 x 63	16	4,71	-	36	-	
A31RMR190H00	90 x 75	16	6,75	-	36	-	
A31RMR111I00	110 x 90	16	10,20	-	42	-	
A31RMR113L00	125 x 110	16	16,00	-	20	-	
A31RMR115L00	140 x 110	16	25,30	-	12	-	

90° reduced tee

reducing bush



TR1

Ref.	D x D x D	PFA (PN)	€	pack	box	type	stock
A31RTR120A00	20 x 16 x 20	16	0,80	-	180	-	
A31RTR125A00	25 x 16 x 25	16	0,94	-	250	-	
A31RTR125B00	25 x 20 x 25	16	0,94	-	250	-	
A31RTR132A00	32 x 16 x 32	16	1,30	-	160	-	
A31RTR132B00	32 x 20 x 32	16	1,30	-	160	-	
A31RTR132C00	32 x 25 x 32	16	1,30	-	140	-	
A31RTR140A00	40 x 16 x 40	16	1,77	-	-	-	
A31RTR140B00	40 x 20 x 40	16	1,77	-	100	-	
A31RTR140C00	40 x 25 x 40	16	1,77	-	90	-	
A31RTR140D00	40 x 32 x 40	16	1,77	-	90	-	
A31RTR150B00	50 x 20 x 50	16	2,81	-	110	-	
A31RTR150C00	50 x 25 x 50	16	2,81	-	110	-	
A31RTR150D00	50 x 32 x 50	16	2,81	-	110	-	
A31RTR150E00	50 x 40 x 50	16	2,81	-	100	-	
A31RTR163B00	63 x 20 x 63	16	4,34	-	-	-	
A31RTR163C00	63 x 25 x 63	16	4,34	-	70	-	
A31RTR163D00	63 x 32 x 63	16	4,34	-	70	-	
A31RTR163E00	63 x 40 x 63	16	4,34	-	60	-	
A31RTR163F00	63 x 50 x 63	16	4,34	-	60	-	
A31RTR175D00	75 x 32 x 75	16	7,42	-	-	-	
A31RTR175E00	75 x 40 x 75	16	7,42	-	32	-	
A31RTR175F00	75 x 50 x 75	16	7,42	-	32	-	
A31RTR175G00	75 x 63 x 75	16	7,42	-	32	-	
A31RTR190E00	90 x 40 x 90	16	10,50	-	-	-	
A31RTR190F00	90 x 50 x 90	16	10,50	-	24	-	
A31RTR190G00	90 x 63 x 90	16	10,50	-	22	-	
A31RTR190H00	90 x 75 x 90	16	10,50	-	12	-	
A31RTR111F00	110 x 50 x 110	16	18,00	-	12	-	
A31RTR111G00	110 x 63 x 110	16	18,00	-	10	-	
A31RTR111H00	110 x 75 x 110	16	18,00	-	12	-	
A31RTR111I00	110 x 90 x 110	16	18,00	-	10	-	
A31RTR117L00	160 x 110 x 160	16	67,40	-	3	-	



RC1

Ref.	D x D	PFA (PN)	€	pack	box	type	stock
A31RRC120A00	20 x 16	16	0,45	-	1.000	-	
A31RRC125A00	25 x 16	16	0,47	-	700	-	
A31RRC125B00	25 x 20	16	0,47	-	700	-	
A31RRC132A00	32 x 16	16	0,66	-	450	-	
A31RRC132B00	32 x 20	16	0,66	-	400	-	
A31RRC132C00	32 x 25	16	0,66	-	450	-	
A31RRC140B00	40 x 20	16	0,73	-	270	-	
A31RRC140C00	40 x 25	16	0,73	-	250	-	
A31RRC140D00	40 x 32	16	0,73	-	300	-	
A31RRC150B00	50 x 20	16	0,87	-	-	-	
A31RRC150C00	50 x 25	16	0,87	-	350	-	
A31RRC150D00	50 x 32	16	0,87	-	350	-	
A31RRC150E00	50 x 40	16	0,87	-	350	-	
A31RRC163D00	63 x 32	16	1,18	-	180	-	
A31RRC163E00	63 x 40	16	1,18	-	180	-	
A31RRC163F00	63 x 50	16	1,18	-	180	-	
A31RRC175E00	75 x 40	16	2,19	-	110	-	
A31RRC175F00	75 x 50	16	2,19	-	110	-	
A31RRC175G00	75 x 63	16	2,19	-	110	-	
A31RRC190F00	90 x 50	16	3,56	-	65	-	
A31RRC190G00	90 x 63	16	3,56	-	65	-	
A31RRC190H00	90 x 75	16	3,56	-	65	-	
A31RRC111G00	110 x 63	16	4,93	-	40	-	
A31RRC111H00	110 x 75	16	4,93	-	40	-	
A31RRC111I00	110 x 90	16	4,93	-	40	-	
A31RRC113H00	125 x 75	16	9,33	-	50	-	
A31RRC113I00	125 x 90	16	9,33	-	50	-	
A31RRC113L00	125 x 110	16	9,33	-	50	-	
A31RRC115L00	140 x 110	16	13,40	-	40	-	
A31RRC115M00	140 x 125	16	13,40	-	40	-	
A31RRC117I00	160 x 90	16	14,50	-	40	-	
A31RRC117L00	160 x 110	16	14,50	-	24	-	
A31RRC117M00	160 x 125	16	14,50	-	24	-	
A31RRC117N00	160 x 140	16	14,50	-	24	-	
A31RRC121O00	200 x 160	10	28,10	-	12	-	
A31RRC123O00	225 x 160	10	34,60	-	7	-	
A31RRC123P00	225 x 200	10	35,80	-	7	-	
A31RRC126O00	250 x 160	10	*	-	6	-	
A31RRC126P00	250 x 200	10	*	-	1	-	



CU1

Ref.	D	PFA (PN)	€	pack	box	type	stock
A31RCU120000	20	16	2,90	-	300	-	
A31RCU125000	25	16	3,24	-	150	-	
A31RCU132000	32	16	4,36	-	100	-	
A31RCU140000	40	16	5,92	-	50	-	
A31RCU150000	50	16	8,27	-	60	-	
A31RCU163000	63	16	10,90	-	30	-	
A31RCU175000	75	16	24,10	-	15	-	
A31RCU190000	90	16	30,10	-	9	-	
A31RCU111000	110	16	48,50	-	6	-	
A31RCU117000	160	16	*	-	-	-	

90° bend



TY1

Ref.	D	PFA (PN)	€	pack	box	type	stock
A31RTY132000	32	16	3,54	-	90	-	
A31RTY140000	40	16	4,81	-	50	-	
A31RTY150000	50	16	6,28	-	35	-	
A31RTY163000	63	16	8,65	-	18	-	

45° tee



CA1

Ref.	D	PFA (PN)	€	pack	box	type	stock
A31RCA116000	16	16	0,50	-	600	-	
A31RCA120000	20	16	0,58	-	500	-	
A31RCA125000	25	16	0,64	-	350	-	
A31RCA132000	32	16	0,77	-	400	-	
A31RCA140000	40	16	1,07	-	300	-	
A31RCA150000	50	16	1,45	-	180	-	
A31RCA163000	63	16	1,96	-	100	-	
A31RCA175000	75	16	4,13	-	60	-	
A31RCA190000	90	16	5,76	-	65	-	
A31RCA111000	110	16	8,12	-	40	-	
A31RCA113000	125	16	14,20	-	33	-	
A31RCA115000	140	16	15,00	-	20	-	
A31RCA117000	160	16	20,80	-	14	-	

cap

\* on request



loose flange

Ref.	D	PFA (PN)	€	pack	box	type	stock
A31RFL120000	20	16	2,20	-	200	-	
A31RFL125000	25	16	2,41	-	100	-	
A31RFL132000	32	16	2,79	-	80	-	
A31RFL140000	40	16	3,93	-	100	-	
A31RFL150000	50	16	4,29	-	80	-	
A31RFL163000	63	16	4,61	-	50	-	
A31RFL175000	75	16	5,85	-	40	-	
A31RFL190000	90	16	6,57	-	35	-	
A31RFL111000	110	16	8,20	-	24	-	
A31RFL113000	125	16	11,90	-	20	-	
A31RFL115000	140	16	13,60	-	15	-	
A31RFL117000	160	16	15,80	-	20	-	
A31RFL121000	200	10	34,30	-	10	-	
A31RFL123000	225	10	37,60	-	10	-	
A31RFL126000	250	10	149,90	-	6	-	
A31RFL128000	280	10	*	-	-	-	
A31RFL133000	315	10	165,90	-	1	-	



blind flange

Ref.	D	PFA (PN)	€	pack	box	type	stock
A31RFC120000	20	16	2,66	-	250	-	
A31RFC125000	25	16	3,02	-	150	-	
A31RFC132000	32	16	4,09	-	80	-	
A31RFC140000	40	16	5,20	-	100	-	
A31RFC150000	50	16	6,23	-	80	-	
A31RFC163000	63	16	7,36	-	50	-	
A31RFC175000	75	16	8,23	-	40	-	
A31RFC190000	90	16	9,69	-	30	-	
A31RFC111000	110	16	12,50	-	20	-	



stub

Ref.	D	PFA (PN)	€	pack	box	type	stock
A31RQR120000	20	16	0,61	-	600	-	
A31RQR125000	25	16	0,68	-	300	-	
A31RQR132000	32	16	0,71	-	200	-	
A31RQR140000	40	16	1,04	-	200	-	
A31RQR150000	50	16	1,61	-	180	-	
A31RQR163000	63	16	2,62	-	90	-	
A31RQR175000	75	16	4,13	-	120	-	
A31RQR190000	90	16	5,05	-	70	-	
A31RQR111000	110	16	6,61	-	40	-	
A31RQR113000	125	16	14,10	-	25	-	
A31RQR115000	140	16	15,40	-	20	-	
A31RQR117000	160	16	17,20	-	15	-	
A31RQR121000	200	10	33,10	-	7	-	
A31RQR123000	225	10	40,70	-	4	-	
A31RQR126000	250	10	44,70	-	4	-	
A31RQR128000	280	10	*	-	-	-	
A31RQR133000	315	10	111,90	-	1	-	



fixed flange

Ref.	D	PFA (PN)	€	pack	box	type	stock
A31RFF120000	20	16	2,58	-	120	-	
A31RFF125000	25	16	3,39	-	80	-	
A31RFF132000	32	16	3,98	-	50	-	
A31RFF140000	40	16	5,10	-	40	-	
A31RFF150000	50	16	6,01	-	48	-	
A31RFF163000	63	16	7,31	-	36	-	
A31RFF175000	75	16	8,72	-	15	-	
A31RFF190000	90	16	10,40	-	10	-	
A31RFF111000	110	16	13,40	-	20	-	

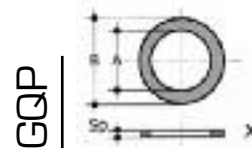

flat gasket for QR1

Ref.	D	PFA (PN)	€	pack	box	type	stock
A31RGQP20000	20	-	0,38	-	-	-	
A31RGQP25000	25	-	0,53	-	-	-	
A31RGQP32000	32	-	0,53	-	-	-	
A31RGQP40000	40	-	0,64	-	-	-	
A31RGQP50000	50	-	0,86	-	-	-	
A31RGQP63000	63	-	0,96	-	-	-	
A31RGQP75000	75	-	1,23	-	-	-	
A31RGQP90000	90	-	1,46	-	-	-	
A31RGQP11000	110	-	2,07	-	-	-	
A31RGQP13000	125	-	2,71	-	-	-	
A31RGQP15000	140	-	3,00	-	-	-	
A31RGQP17000	160	-	3,53	-	-	-	
A31RGQP21000	200	-	5,51	-	-	-	
A31RGQP23000	225	-	6,88	-	-	-	
A31RGQP26000	250	-	12,90	-	-	-	

\* on request

**B01**



union with o-ring

Ref.	D	PFA (PN)	€	pack	box	type	stock
A31RBO116000	16	16	<b>2,19</b>	-	300	-	
A31RBO120000	20	16	<b>2,32</b>	-	150	-	
A31RBO125000	25	16	<b>2,76</b>	-	200	-	
A31RBO132000	32	16	<b>3,07</b>	-	120	-	
A31RBO140000	40	16	<b>4,47</b>	-	80	-	
A31RBO150000	50	16	<b>5,88</b>	-	60	-	
A31RBO163000	63	16	<b>7,80</b>	-	30	-	
A31RBO175000	75	16	<b>21,40</b>	-	30	-	
A31RBO190000	90	16	<b>25,10</b>	-	25	-	
A31RBO111000	110	16	<b>29,00</b>	-	15	-	

**P01**



hose adaptor

Ref.	D	PFA (PN)	€	pack	box	type	stock
A31RPO116000	16	16	<b>0,54</b>	-	500	-	
A31RPO120000	20	16	<b>0,71</b>	-	300	-	
A31RPO125000	25	16	<b>0,79</b>	-	150	-	
A31RPO132000	32	16	<b>0,94</b>	-	250	-	
A31RPO140000	40	16	<b>1,31</b>	-	300	-	
A31RPO150000	50	16	<b>1,69</b>	-	180	-	
A31RPO163000	63	16	<b>2,79</b>	-	60	-	

**MSP**



PVC long sliding sleeve

Ref.	D x L	€	pack	box	type	stock
IIMSP1000G063	63 x 530	<b>28,00</b>	1	-	-	
IIMSP1000G075	75 x 530	<b>32,00</b>	1	-	-	
IIMSP1000G090	90 x 530	<b>39,30</b>	1	-	-	
IIMSP1000G110	110 x 530	<b>48,40</b>	1	-	-	
IIMSP1000G130	125 x 530	<b>61,50</b>	1	-	-	
IIMSP1000G150	140 x 530	<b>78,50</b>	1	-	-	
IIMSP1000G170	160 x 530	<b>94,90</b>	1	-	-	
IIMSP1000G180	180 x 530	<b>130,10</b>	1	-	-	
IIMSP1000G210	200 x 530	<b>157,70</b>	1	-	-	
IIMSP1000G230	225 x 550	<b>219,40</b>	1	-	-	
IIMSP1000G260	250 x 600	<b>318,20</b>	1	-	-	
IIMSP1000G280	280 x 600	<b>376,80</b>	1	-	-	
IIMSP1000G310	315 x 650	<b>474,10</b>	1	-	-	

**ST1**



pipe clip

Ref.	D	PFA (PN)	€	pack	box	type	stock
A31RST116000	16	-	<b>0,42</b>	-	800	-	
A31RST120000	20	-	<b>0,42</b>	-	500	-	
A31RST125000	25	-	<b>0,47</b>	-	300	-	
A31RST132000	32	-	<b>0,53</b>	-	450	-	
A31RST140000	40	-	<b>0,63</b>	-	300	-	
A31RST150000	50	-	<b>0,79</b>	-	150	-	
A31RST163000	63	-	<b>1,01</b>	-	10	-	
A31RST175000	75	-	<b>4,34</b>	-	10	-	
A31RST190000	90	-	<b>6,39</b>	-	10	-	
A31RST111000	110	-	<b>7,32</b>	-	10	-	

90° tee

T12



Ref.	D	PFA (PN)	€	pack	box	type	stock
A31RTI216000	3/8"	16	1,61	-	300	-	
A31RTI220000	1/2"	16	1,85	-	400	-	
A31RTI225000	3/4"	16	1,99	-	240	-	
A31RTI232000	1"	16	2,42	-	100	-	
A31RTI240000	1" 1/4	16	3,41	-	70	-	
A31RTI250000	1" 1/2	16	4,37	-	90	-	
A31RTI263000	2"	16	6,25	-	50	-	
A31RTI275000	2" 1/2	16	16,20	-	32	-	
A31RTI290000	3"	16	19,30	-	20	-	
A31RTI211000	4"	16	29,40	-	10	-	

nipple

N12



Ref.	G	PFA (PN)	€	pack	box	type	stock
A31RNI216000	3/8"	16	0,64	-	1.000	-	
A31RNI220000	1/2"	16	0,69	-	450	-	
A31RNI225000	3/4"	16	0,81	-	600	-	
A31RNI232000	1"	16	1,01	-	350	-	
A31RNI240000	1" 1/4	16	1,29	-	220	-	
A31RNI250000	1" 1/2	16	1,55	-	200	-	
A31RNI263000	2"	16	2,07	-	200	-	
A31RNI275000	2" 1/2	16	5,55	-	110	-	
A31RNI290000	3"	16	7,62	-	70	-	
A31RNI211000	4"	16	12,10	-	35	-	

90° elbow

G02



Ref.	G	PFA (PN)	€	pack	box	type	stock
A31RGO216000	3/8"	16	0,88	-	350	-	
A31RGO220000	1/2"	16	0,88	-	250	-	
A31RGO225000	3/4"	16	1,10	-	350	-	
A31RGO232000	1"	16	1,39	-	200	-	
A31RGO240000	1" 1/4	16	1,96	-	120	-	
A31RGO250000	1" 1/2	16	2,95	-	140	-	
A31RGO263000	2"	16	4,20	-	70	-	
A31RGO275000	2" 1/2	16	10,60	-	40	-	
A31RGO290000	3"	16	14,60	-	25	-	
A31RGO211000	4"	16	23,90	-	14	-	

reducing nipple

NR2



Ref.	G	PFA (PN)	€	pack	box	type	stock
A31RNR220A00	1/2" x 3/8"	16	1,04	-	650	-	
A31RNR225B00	3/4" x 1/2"	16	1,15	-	350	-	
A31RNR232C00	1" x 3/4"	16	1,42	-	450	-	
A31RNR240D00	1" 1/4 x 1"	16	1,85	-	270	-	
A31RNR250E00	1" 1/2 x 1" 1/4	16	2,36	-	180	-	
A31RNR263F00	2" x 1" 1/2	16	3,34	-	110	-	
A31RNR275G00	2" 1/2 x 2"	16	6,10	-	80	-	
A31RNR290H00	3" x 2" 1/2	16	7,88	-	35	-	
A31RNR21100	4" x 3"	16	12,10	-	24	-	

coupling

MA2



Ref.	G	PFA (PN)	€	pack	box	type	stock
A31RMA216000	3/8"	16	0,92	-	450	-	
A31RMA220000	1/2"	16	1,06	-	350	-	
A31RMA225000	3/4"	16	1,16	-	450	-	
A31RMA232000	1"	16	1,42	-	250	-	
A31RMA240000	1" 1/4	16	1,83	-	190	-	
A31RMA250000	1" 1/2	16	2,42	-	140	-	
A31RMA263000	2"	16	3,17	-	85	-	
A31RMA275000	2" 1/2	16	9,14	-	45	-	
A31RMA290000	3"	16	10,90	-	60	-	
A31RMA211000	4"	16	15,80	-	30	-	

male / female reducer

R12



Ref.	G	PFA (PN)	€	pack	box	type	stock
A31RRI220A00	1/2" x 3/8"	16	0,82	-	500	-	
A31RRI225A00	3/4" x 3/8"	16	0,82	-	400	-	
A31RRI225B00	3/4" x 1/2"	16	0,82	-	280	-	
A31RRI232A00	1" x 3/8"	16	0,98	-	500	-	
A31RRI232B00	1" x 1/2"	16	0,98	-	500	-	
A31RRI232C00	1" x 3/4"	16	0,98	-	450	-	
A31RRI240B00	1" 1/4 x 1/2"	16	1,43	-	300	-	
A31RRI240C00	1" 1/4 x 3/4"	16	1,43	-	280	-	
A31RRI240D00	1" 1/4 x 1"	16	1,43	-	260	-	
A31RRI250C00	1" 1/2 x 3/4"	16	1,85	-	220	-	
A31RRI250D00	1" 1/2 x 1"	16	1,85	-	220	-	
A31RRI250E00	1" 1/2 x 1" 1/4	16	1,85	-	180	-	
A31RRI263D00	2" x 1"	16	2,53	-	130	-	
A31RRI263E00	2" x 1" 1/4	16	2,53	-	120	-	
A31RRI263F00	2" x 1" 1/2	16	2,53	-	120	-	
A31RRI275E00	2" 1/2 x 1" 1/4	16	5,64	-	60	-	
A31RRI275F00	2" 1/2 x 1" 1/2	16	5,64	-	60	-	
A31RRI275G00	2" 1/2 x 2"	16	5,64	-	60	-	
A31RRI290F00	3" x 1" 1/2	16	7,42	-	40	-	
A31RRI290G00	3" x 2"	16	7,42	-	30	-	
A31RRI290H00	3" x 2" 1/2	16	7,42	-	40	-	
A31RRI211G00	4" x 2"	16	12,10	-	40	-	
A31RRI211H00	4" x 2" 1/2	16	12,10	-	40	-	
A31RRI211I00	4" x 3"	16	12,10	-	40	-	



cap

CA2



Ref.	G	PFA (PN)	€	pack	box	type	stock
A31RCA216000	3/8"	16	<b>0,72</b>	-	1.000	-	
A31RCA220000	1/2"	16	<b>0,81</b>	-	500	-	
A31RCA225000	3/4"	16	<b>0,91</b>	-	300	-	
A31RCA232000	1"	16	<b>1,01</b>	-	180	-	
A31RCA240000	1" 1/4	16	<b>1,49</b>	-	120	-	
A31RCA250000	1" 1/2	16	<b>1,78</b>	-	230	-	
A31RCA263000	2"	16	<b>2,42</b>	-	120	-	
A31RCA275000	2" 1/2	16	<b>8,17</b>	-	60	-	
A31RCA290000	3"	16	<b>10,60</b>	-	30	-	
A31RCA211000	4"	16	<b>13,60</b>	-	25	-	

male / female adaptor

MG2



Ref.	G x G	PFA (PN)	€	pack	box	type	stock
A31RMG216B00	3/8" x 1/2"	16	<b>1,37</b>	-	500	-	
A31RMG220C00	1/2" x 3/4"	16	<b>1,45</b>	-	250	-	
A31RMG225D00	3/4" x 1"	16	<b>1,54</b>	-	150	-	
A31RMG232E00	1" x 1" 1/4	16	<b>1,67</b>	-	220	-	
A31RMG240F00	1" 1/4 x 1" 1/2	16	<b>1,93</b>	-	150	-	
A31RMG250G00	1" 1/2 x 2"	16	<b>2,51</b>	-	140	-	
A31RMG263H00	2" x 2" 1/2	16	<b>5,08</b>	-	72	-	
A31RMG275I00	2" 1/2 x 3"	16	<b>6,82</b>	-	50	-	
A31RMG290L00	3" x 4"	16	<b>11,50</b>	-	25	-	

reduced socket

MR2



Ref.	G x G	PFA (PN)	€	pack	box	type	stock
A31RMR220A00	1/2" x 3/8"	16	<b>1,55</b>	-	450	-	
A31RMR225B00	3/4" x 1/2"	16	<b>1,55</b>	-	450	-	
A31RMR232C00	1" x 3/4"	16	<b>1,68</b>	-	300	-	
A31RMR240D00	1" 1/4 x 1"	16	<b>2,07</b>	-	200	-	
A31RMR250E00	1" 1/2 x 1" 1/4	16	<b>3,03</b>	-	160	-	
A31RMR263F00	2" x 1" 1/2	16	<b>4,18</b>	-	100	-	
A31RMR275G00	2" 1/2 x 2"	16	<b>9,18</b>	-	50	-	
A31RMR290H00	3" x 2" 1/2	16	<b>11,00</b>	-	50	-	
A31RMR211I00	4" x 3"	16	<b>15,80</b>	-	35	-	

plug

TA2



Ref.	G	PFA (PN)	€	pack	box	type	stock
A31RTA216000	3/8"	16	<b>0,50</b>	-	1.200	-	
A31RTA220000	1/2"	16	<b>0,53</b>	-	650	-	
A31RTA225000	3/4"	16	<b>0,72</b>	-	400	-	
A31RTA232000	1"	16	<b>0,88</b>	-	500	-	
A31RTA240000	1" 1/4	16	<b>1,22</b>	-	350	-	
A31RTA250000	1" 1/2	16	<b>1,42</b>	-	280	-	
A31RTA263000	2"	16	<b>1,95</b>	-	100	-	
A31RTA275000	2" 1/2	16	<b>6,15</b>	-	80	-	
A31RTA290000	3"	16	<b>7,88</b>	-	50	-	
A31RTA211000	4"	16	<b>13,10</b>	-	36	-	

45° elbow

GY2



Ref.	G	PFA (PN)	€	pack	box	type	stock
A31RGY220000	1/2"	16	<b>1,47</b>	-	300	-	
A31RGY225000	3/4"	16	<b>1,56</b>	-	400	-	
A31RGY232000	1"	16	<b>2,01</b>	-	200	-	
A31RGY240000	1" 1/4	16	<b>2,79</b>	-	150	-	
A31RGY250000	1" 1/2	16	<b>4,12</b>	-	170	-	
A31RGY263000	2"	16	<b>5,83</b>	-	90	-	
A31RGY275000	2" 1/2	16	<b>13,10</b>	-	50	-	
A31RGY290000	3"	16	<b>16,80</b>	-	30	-	
A31RGY211000	4"	16	<b>29,60</b>	-	16	-	

union with o-ring

B02



Ref.	G	PFA (PN)	€	pack	box	type	stock
A31RBO216000	3/8"	16	<b>3,07</b>	-	300	-	
A31RBO220000	1/2"	16	<b>3,07</b>	-	350	-	
A31RBO225000	3/4"	16	<b>3,64</b>	-	200	-	
A31RBO232000	1"	16	<b>4,18</b>	-	120	-	
A31RBO240000	1" 1/4	16	<b>5,10</b>	-	80	-	
A31RBO250000	1" 1/2	16	<b>7,02</b>	-	60	-	
A31RBO263000	2"	16	<b>9,64</b>	-	30	-	
A31RBO275000	2" 1/2	16	<b>27,20</b>	-	30	-	
A31RBO290000	3"	16	<b>31,60</b>	-	25	-	
A31RBO211000	4"	16	<b>36,40</b>	-	15	-	

hose adaptor

P02



Ref.	G	PFA (PN)	€	pack	box	type	stock
A31RPO216000	3/8"	16	<b>0,61</b>	-	500	-	
A31RPO220000	1/2"	16	<b>0,79</b>	-	300	-	
A31RPO225000	3/4"	16	<b>0,94</b>	-	180	-	
A31RPO232000	1"	16	<b>1,01</b>	-	250	-	
A31RPO240000	1" 1/4	16	<b>1,78</b>	-	300	-	
A31RPO250000	1" 1/2	16	<b>2,19</b>	-	100	-	
A31RPO263000	2"	16	<b>3,56</b>	-	60	-	

90° tee

T13



Ref.	D x G	PFA (PN)	€	pack	box	type	stock
A31RTI316A00	16 x 3/8"	16	1,17	-	300	-	
A31RTI320B00	20 x 1/2"	16	1,35	-	400	-	
A31RTI325C00	25 x 3/4"	16	1,48	-	240	-	
A31RTI332D00	32 x 1"	16	2,18	-	100	-	
A31RTI340E00	40 x 1 1/4"	16	2,47	-	80	-	
A31RTI350F00	50 x 1 1/2"	16	3,69	-	90	-	
A31RTI363G00	63 x 2"	16	6,57	-	50	-	
A31RTI375H00	75 x 2 1/2"	16	12,00	-	32	-	
A31RTI390I00	90 x 3"	16	16,70	-	20	-	
A31RTI311L00	110 x 4"	16	27,20	-	10	-	

male threaded adaptor

AM3



Ref.	D x D x G	PFA (PN)	€	pack	box	type	stock
A31RAM312A00	12 x 16 x 3/8"	16	0,63	-	1.000	-	
A31RAM316A00	16 x 20 x 3/8"	16	0,64	-	500	-	
A31RAM316B00	16 x 20 x 1/2"	16	0,64	-	450	-	
A31RAM320A00	20 x 25 x 3/8"	16	0,69	-	300	-	
A31RAM320B00	20 x 25 x 1/2"	16	0,69	-	300	-	
A31RAM320C00	20 x 25 x 3/4"	16	0,69	-	250	-	
A31RAM325B00	25 x 32 x 1/2"	16	0,77	-	400	-	
A31RAM325C00	25 x 32 x 3/4"	16	0,77	-	400	-	
A31RAM325D00	25 x 32 x 1"	16	0,81	-	350	-	
A31RAM332C00	32 x 40 x 1/2"	16	0,98	-	300	-	
A31RAM332D00	32 x 40 x 1"	16	0,98	-	250	-	
A31RAM332E00	32 x 40 x 1 1/4"	16	1,15	-	200	-	
A31RAM340D00	40 x 50 x 1"	16	1,42	-	160	-	
A31RAM340E00	40 x 50 x 1 1/4"	16	1,42	-	150	-	
A31RAM340F00	40 x 50 x 1 1/2"	16	1,63	-	140	-	
A31RAM350E00	50 x 63 x 1 1/4"	16	2,19	-	120	-	
A31RAM350F00	50 x 63 x 1 1/2"	16	2,19	-	120	-	
A31RAM350G00	50 x 63 x 2"	16	2,19	-	100	-	
A31RAM363F00	63 x 75 x 1 1/2"	16	2,92	-	70	-	
A31RAM363G00	63 x 75 x 2"	16	2,92	-	70	-	
A31RAM363H00	63 x 75 x 2 1/2"	16	5,72	-	60	-	
A31RAM375G00	75 x 90 x 2"	16	6,88	-	45	-	
A31RAM375H00	75 x 90 x 2 1/2"	16	7,48	-	45	-	
A31RAM375I00	75 x 90 x 3"	16	7,98	-	40	-	
A31RAM390G00	90 x 110 x 2"	16	9,18	-	-	-	
A31RAM390H00	90 x 110 x 2 1/2"	16	9,18	-	45	-	
A31RAM390I00	90 x 110 x 3"	16	9,18	-	45	-	
A31RAM390L00	90 x 110 x 4"	16	11,50	-	36	-	
A31RAM311I00	110 x 125 x 3"	16	13,10	-	36	-	
A31RAM311L00	110 x 125 x 4"	16	13,60	-	30	-	

90° elbow

G03



Ref.	D x G	PFA (PN)	€	pack	box	type	stock
A31RGO316A00	16 x 3/8"	16	0,91	-	350	-	
A31RGO320B00	20 x 1/2"	16	1,01	-	250	-	
A31RGO325C00	25 x 3/4"	16	1,18	-	350	-	
A31RGO332D00	32 x 1"	16	1,37	-	200	-	
A31RGO340E00	40 x 1 1/4"	16	2,69	-	120	-	
A31RGO350F00	50 x 1 1/2"	16	3,72	-	140	-	
A31RGO363G00	63 x 2"	16	5,10	-	70	-	
A31RGO375H00	75 x 2 1/2"	16	10,50	-	40	-	
A31RGO390I00	90 x 3"	16	15,30	-	25	-	
A31RGO311L00	110 x 4"	16	23,70	-	14	-	

coupling

MA3



Ref.	D x G	PFA (PN)	€	pack	box	type	stock
A31RMA316A00	16 x 3/8"	16	0,96	-	450	-	
A31RMA320B00	20 x 1/2"	16	1,05	-	350	-	
A31RMA325C00	25 x 3/4"	16	1,14	-	450	-	
A31RMA332D00	32 x 1"	16	1,31	-	250	-	
A31RMA340E00	40 x 1 1/4"	16	1,63	-	180	-	
A31RMA350F00	50 x 1 1/2"	16	2,47	-	120	-	
A31RMA363G00	63 x 2"	16	3,65	-	75	-	
A31RMA375H00	75 x 2 1/2"	16	9,67	-	45	-	
A31RMA390I00	90 x 3"	16	10,50	-	54	-	
A31RMA311L00	110 x 4"	16	15,40	-	30	-	

union with o-ring

B03



Ref.	D x G	PFA (PN)	€	pack	box	type	stock
A31RBO316A00	16 x 3/8"	16	2,85	-	300	-	
A31RBO320B00	20 x 1/2"	16	3,00	-	150	-	
A31RBO325C00	25 x 3/4"	16	3,51	-	200	-	
A31RBO332D00	32 x 1"	16	4,66	-	120	-	
A31RBO340E00	40 x 1 1/4"	16	5,46	-	80	-	
A31RBO350F00	50 x 1 1/2"	16	7,67	-	60	-	
A31RBO363G00	63 x 2"	16	9,80	-	30	-	
A31RBO375H00	75 x 2 1/2"	16	26,30	-	30	-	
A31RBO390I00	90 x 3"	16	30,80	-	25	-	
A31RBO311L00	110 x 4"	16	35,50	-	15	-	

female threaded adaptor

AF3



Ref.	D x G	PFA (PN)	€	pack	box	type	stock
A31RAF316A00	16 x 3/8"	16	1,15	-	600	-	
A31RAF320B00	20 x 1/2"	16	1,29	-	350	-	
A31RAF320C00	20 x 3/4"	16	1,42	-	300	-	
A31RAF325B00	25 x 1/2"	16	1,27	-	500	-	
A31RAF325C00	25 x 3/4"	16	1,49	-	450	-	
A31RAF325D00	25 x 1"	16	1,55	-	400	-	
A31RAF332C00	32 x 3/4"	16	1,49	-	250	-	
A31RAF332D00	32 x 1"	16	1,80	-	250	-	
A31RAF340D00	40 x 1"	16	1,85	-	200	-	
A31RAF340E00	40 x 1 1/4"	16	1,95	-	180	-	
A31RAF350E00	50 x 1 1/4"	16	2,18	-	140	-	
A31RAF350F00	50 x 1 1/2"	16	2,42	-	130	-	
A31RAF350G00	50 x 2"	16	3,34	-	110	-	
A31RAF363G00	63 x 2"	16	4,08	-	70	-	
A31RAF375G00	75 x 2"	16	5,23	-	60	-	
A31RAF375H00	75 x 2 1/2"	16	7,42	-	80	-	
A31RAF375I00	75 x 3"	16	8,12	-	35	-	
A31RAF390H00	90 x 2 1/2"	16	8,12	-	60	-	
A31RAF390I00	90 x 3"	16	9,18	-	55	-	
A31RAF390L00	90 x 4"	16	11,40	-	35	-	
A31RAF311I00	110 x 3"	16	11,40	-	35	-	
A31RAF311L00	110 x 4"	16	13,10	-	35	-	

301



F/F threaded gate ball valve

Ref.	G	PFA (PN)	€	pack	box	type	stock
A21V30116000	3/8"	16	6,07	1	-	-	
A21V30120000	1/2"	16	6,07	1	60	-	
A21V30125000	3/4"	16	6,83	1	40	-	
A21V30132000	1"	16	8,48	1	60	-	
A21V30140000	1" 1/4	16	10,80	1	30	-	
A21V30150000	1" 1/2	16	15,90	1	20	-	
A21V30163000	2"	16	23,70	1	12	-	
A21V30175000	2" 1/2	10	55,90	1	4	-	
A21V30190000	3"	10	68,30	1	4	-	
A21V30111000	4"	6	106,70	1	2	-	

302



weld mounted threaded gate ball valve

Ref.	D	PFA (PN)	€	pack	box	type	stock
A21V30216000	16	16	4,74	1	-	-	
A21V30220000	20	16	4,74	1	60	-	
A21V30225000	25	16	5,81	1	40	-	
A21V30232000	32	16	6,28	1	60	-	
A21V30240000	40	16	9,78	1	30	-	
A21V30250000	50	16	13,40	1	20	-	
A21V30263000	63	16	22,40	1	12	-	
A21V30275000	75	10	48,30	1	4	-	
A21V30290000	90	10	55,90	1	4	-	
A21V30211000	110	6	98,70	1	2	-	

303



M/F threaded gate ball valve

Ref.	G	PFA (PN)	€	pack	box	type	stock
A21V30316000	3/8"	16	6,20	1	-	-	
A21V30320000	1/2"	16	6,20	1	60	-	
A21V30325000	3/4"	16	6,93	1	40	-	
A21V30332000	1"	16	7,67	1	60	-	
A21V30340000	1" 1/4	16	10,80	1	30	-	
A21V30350000	1" 1/2	16	14,60	1	20	-	
A21V30363000	2"	16	23,70	1	12	-	

305



threaded gate ball valve with compression joint

Ref.	D x G	PFA (PN)	€	pack	box	type	stock
A21V30520000	20 x 1/2"	16	10,00	1	100	-	
A21V30525000	25 x 3/4"	16	11,10	1	50	-	
A21V30532000	32 x 1"	16	12,40	1	40	-	
A21V30540000	40 x 1" 1/4	16	17,60	1	-	-	
A21V30550000	50 x 1" 1/2	16	18,30	1	-	-	
A21V30563000	63 x 2"	16	38,50	1	-	-	

324



weld mounted threaded double gate ball valve

Ref.	D	PFA (PN)	€	pack	box	type	stock
A21V32416000	16	16	7,35	1	50	-	
A21V32420000	20	16	7,35	1	50	-	
A21V32425000	25	16	8,38	1	30	-	
A21V32432000	32	16	11,30	1	50	-	
A21V32440000	40	16	14,80	1	30	-	
A21V32450000	50	16	17,40	1	20	-	
A21V32463000	63	16	26,30	1	12	-	
A21V32475000	75	10	83,00	1	3	-	
A21V32490000	90	10	108,70	1	3	-	
A21V32411000	110	6	142,90	1	2	-	

322



weld mounted threaded double gate ball valve  
(until stocks last)

Ref.	D	PFA (PN)	€	pack	box	type	stock
A21V32250000	50	16	17,40	1	20	-	
A21V32275000	75	10	83,00	1	3	-	
A21V32290000	90	10	108,70	1	3	-	

325



threaded double gate ball valve F/F

Ref.	G	PFA (PN)	€	pack	box	type	stock
A21V32516000	3/8"	16	7,72	1	50	-	
A21V32520000	1/2"	16	7,72	1	50	-	
A21V32525000	3/4"	16	8,24	1	30	-	
A21V32532000	1"	16	12,00	1	50	-	
A21V32540000	1" 1/4	16	15,10	1	30	-	
A21V32550000	1" 1/2	16	17,60	1	20	-	
A21V32563000	2"	16	27,80	1	12	-	
A21V32575000	2" 1/2	10	85,30	1	3	-	
A21V32590000	3"	10	113,30	1	3	-	
A21V32511000	4"	6	149,40	1	2	-	

321



female thread double gate ball valve  
(until stocks last)

Ref.	G	PFA (PN)	€	pack	box	type	stock
A21V32120000	1/2"	16	7,72	1	120	-	
A21V32140000	1" 1/4	16	15,10	1	30	-	
A21V32175000	2" 1/2	10	85,30	1	3	-	
A21V32111000	4"	6	149,40	1	2	-	

800



butterfly valve

Ref.	D	PFA (PN)	€	pack	box	type	stock
A21V80063000	63	10	109,80	1	-	-	
A21V80075000	75	10	*	1	-	-	
A21V80090000	90	10	125,40	1	-	-	
A21V80011000	110	10	137,80	1	-	-	
A21V80013000	125	10	156,80	1	-	-	
A21V80015000	140	10	168,10	1	-	-	
A21V80017000	160	10	190,80	1	-	-	
A21V80023000	200/225	10	275,40	1	-	-	
A21V80028000	280	6	*	1	-	-	
A21V80033000	315	4	*	1	-	-	

\* on request





	page
Hunter® rotary Pop-up	86-87
Hunter® spray Pop-up	88-89
Hunter® controllers	90-91
Hunter® Electric valves	92
Hunter® sensors	92
Hunter® Accessories	93
Baccara electric valves and controllers	94
Various gardening	95
Hit	96-97
Manifold	98-99
Valve boxes	99
Pop-up adaptors and pipes	100
Gardening accessories	101



## MP R



rotor sprinkler  
series MP Rotator

Hunter®

Ref.	model	radius	€	pack	box	stock
IGMP100090	MP1000 90°+ 210°	2,5 ÷ 4,6	7,25	10	200	■
IGMP1000210	MP1000 210°+ 270°	2,5 ÷ 4,6	7,25	10	200	■
IGMP1000360	MP1000 360°	2,5 ÷ 4,6	7,25	10	200	■
IGMP200090	MP2000 90°+ 210°	4,0 ÷ 6,4	7,65	10	200	■
IGMP2000210	MP2000 210°+ 270°	4,0 ÷ 6,4	7,65	10	200	■
IGMP2000360	MP2000 360°	4,0 ÷ 6,4	7,65	10	200	■
IGMP300090	MP3000 90°+ 210°	6,7 ÷ 9,1	8,05	10	200	■
IGMP3000210	MP3000 210°+ 270°	6,7 ÷ 9,1	8,05	10	200	■
IGMP3000360	MP3000 360°	6,7 ÷ 9,1	8,05	10	200	■
IGMPCORNER	MP CORNER	2,4 ÷ 4,6	7,65	10	200	■
IGMPLCS515	MPLCS515	-	7,65	10	200	■
IGMPRC515	MPRCS515	-	7,65	10	200	■
IGMPSS530	MPSS530	-	7,65	10	200	■

## ECOR



rotor sprinkler  
series ECO Rotator  
(MP Rotator + PS Ultra)

Hunter®

Ref.	model	H	radius	€	box	stock
IGECO041090	MP1000 90°+ PS ultra	100	2,5 ÷ 4,6	8,60	100	■
IGECO042090	MP2000 90°+ PS ultra	100	4,0 ÷ 6,4	9,00	100	■
IGECO043090	MP3000 90°+ PS ultra	100	6,7 ÷ 9,1	9,40	100	■

## MPR 40



body sprinkler for series MP Rotator  
with pressure reducer and non-drip valve

Hunter®

Ref.	model	H	€	box	stock
IGMPR4004CV	MPR 40 - 04 - CV	100	7,25	50	■

## PGJ



Gear-Driven Rotor  
series PGJ

Hunter®

Ref.	model	H	radius	€	pack	box	stock
IGPGJ00	PGJ-00	100	4,3 ÷ 11,6	12,60	-	25	■
IGPGJ04	PGJ-04	100	4,3 ÷ 11,6	13,30	-	25	■
IGPGJ06	PGJ-06	150	4,3 ÷ 11,6	19,60	-	25	■
IGPGJ12	PGJ-12	300	4,3 ÷ 11,6	27,50	-	12	■

## SRM



Gear-Driven Rotor  
series SRM

Hunter®

Ref.	model	H	radius	€	pack	box	stock
IGSRM04	SRM-04	100	4,6 ÷ 11,3	11,00	-	25	■

## PGP



Gear-Driven Rotor  
series PGP

Hunter®

Ref.	model	H	radius	€	pack	box	stock
IGPGP00	PGP-00	100	4,9 ÷ 14,0	13,40	-	20	■
IGPGPADJ	PGP-ADJ	100	6,4 ÷ 15,8	11,40	-	20	■
IGPGP04	PGP-04	100	4,9 ÷ 14,0	12,20	-	20	■
IGPG12CV	PGP-12-CV	300	4,9 ÷ 14,0	32,40	-	12	■

## i20



Gear-Driven Rotor  
series i 20 Ultra

Hunter®

Ref.	model	H	radius	€	pack	box	stock
IGI2000	I20-00	-	4,9 ÷ 14,0	15,70	-	20	■
IGI2004	I20-04	100	4,9 ÷ 14,0	18,10	-	20	■
IGI2004SS	I20-04-SS	100	4,9 ÷ 14,0	24,30	-	20	■
IGI2006	I20-06	150	4,9 ÷ 14,0	32,20	-	20	■
IGI2006SS	I20-06-SS	150	4,9 ÷ 14,0	37,20	-	20	■
IGI2012	I20-12	300	4,9 ÷ 14,0	36,10	-	12	■

## i25



Gear-Driven Rotor  
series i 25

Hunter®

Ref.	model	H	radius	€	pack	box	stock
IGI2504B	I25-04-B	100	11,9 ÷ 21,6	39,20	-	12	■
IGI2504SSB	I25-04-SSB	100	11,9 ÷ 21,6	51,00	-	12	■
IGI2504SSHSB	I25-04-SSHSB	100	11,3 ÷ 20,4	114,00	-	12	■
IGI2506B	I25-06-B	150	11,9 ÷ 21,6	51,00	-	12	■
IGI2506SSB	I25-06-SSB	150	11,9 ÷ 21,6	63,00	-	12	■
IGI2506SSHSB	I25-06-SSHSB	150	11,3 ÷ 20,4	113,70	-	12	■

## i35



Gear-Driven Rotor  
series i 35 Sierra

Hunter®

Ref.	model	H	radius	€	pack	box	stock
IGI3506B	I35-06-B	150	14,0 ÷ 21,6	58,80	-	12	■
IGI3506SSB	I35-06-SSB	150	14,0 ÷ 21,6	70,60	-	12	■
IGI3506SSHSB (s.s.)	I35-06-SSHSB	150	12,5 ÷ 20,4	113,70	-	12	■

i40



Gear-Driven Rotor  
series i 40

**Hunter®**

Ref.	model	H	radius	€	pack	box	stock
IGI4004SSB	I40-04-SSB	100	11,7 ÷ 21,3	<b>74,50</b>	-	12	■
IGI4004SSONB	I40-04-SSONB	100	15,8 ÷ 23,2	<b>82,40</b>	-	12	■
IGI4004SSHBS	I40-04-SSHBS	100	11,7 ÷ 21,3	<b>113,70</b>	-	12	■
IGI4006SSB	I40-06-B	150	11,7 ÷ 21,3	<b>86,30</b>	-	12	■
IGI4006SSONB	I40-06-ONSSB	150	15,8 ÷ 23,2	<b>94,10</b>	-	12	■
IGI4006SSHBS	I40-06-SSHBS	150	11,7 ÷ 21,3	<b>113,80</b>	-	12	■

i60



Gear-Driven Rotor  
series i 60

**Hunter®**

Ref.	model	H	radius	€	pack	box	stock
IGI60ADV	I60-ADV	80	15,2 ÷ 20,1	<b>98,00</b>	-	12	■
IGI6036S	I60-36S	80	15,2 ÷ 20,1	<b>90,10</b>	-	12	■

i90



Gear-Driven Rotor  
series i 90

**Hunter®**

Ref.	model	H	radius	€	pack	box	stock
IGI90ADVB	I90-ADV-B	80	20,4 ÷ 27,4	<b>133,30</b>	-	6	■
IGI9036VB	I90-36V-B	80	20,1 ÷ 29,3	<b>133,30</b>	-	6	■

G 870



Gear-Driven Rotor  
series G 870

**Hunter®**

Ref.	model	H	radius	€	pack	box	stock
IGG870C23S	G-870C	80	16,2 ÷ 22,9	<b>169,00</b>	-	4	■
IGG870E23P8S	G-870E	80	16,2 ÷ 22,9	<b>201,00</b>	-	4	■
IGG875C25S	G-875C	80	17,4 ÷ 21,6	<b>196,00</b>	-	4	■
IGG875E25P8S	G-875E	80	17,4 ÷ 21,6	<b>224,50</b>	-	4	■

G 880



Gear-Driven Rotor  
series G 880

**Hunter®**

Ref.	model	H	radius	€	pack	box	stock
IGG880C48S	G-880C	80	20,4 ÷ 26,8	<b>184,30</b>	-	4	■
IGG880E48P8S	G-880E	80	20,4 ÷ 26,8	<b>208,00</b>	-	4	■

G 990



Gear-Driven Rotor  
series G 990

**Hunter®**

Ref.	model	H	radius	€	pack	box	stock
IGG990C53S	G-990C	80	23,2 ÷ 29,9	<b>196,00</b>	-	4	■
IGG990E53P8S	G-990E	80	23,2 ÷ 29,9	<b>227,40</b>	-	4	■
IGG995C53S	G-995C	80	20,7 ÷ 28,0	<b>219,50</b>	-	4	■
IGG995E53P8S	G-995E	80	20,7 ÷ 28,0	<b>251,00</b>	-	4	■



nozzles kit

**Hunter®**

Ref.	model			€	pack	box	stock
IG461204	461204	G 990 - G 995	-	<b>11,80</b>	1	-	■

ST90



Gear-Driven Rotor  
series ST90

**Hunter®**

Ref.	model	H	radius	€	pack	box	stock
IGST90XX73	ST90XX73	80	28,7 ÷ 35,1	*	-	4	■
IGST90ON73	ST90ON73	80	28,7 ÷ 35,1	*	-	4	■

ST900



rotary sprinkler  
series ST900

**Hunter®**

Ref.	model	H	radius	€	pack	box	stock
IGST900XX73	ST90XX73	80	28,7 ÷ 35,1	*	-	4	■
IGST900ON73	ST90ON73	80	28,7 ÷ 35,1	*	-	4	■

\* on request

PS



spray sprinkler series PS  
with adjustable arc nozzle 0°/360°

(until stocks last)

Hunter®

Ref.	model	H	radius	€	pack	box	stock
IGPS025SS	PS 02 5SS	50	-	<b>3,20</b>	-	100	■
IGPS0410A	PS 04 10A	100	3,0	<b>3,30</b>	-	100	■
IGPS0412A	PS 04 12A	100	3,7	<b>3,30</b>	-	100	■
IGPS0415A	PS 04 15A	100	4,6	<b>3,30</b>	-	100	■
IGPS0417A	PS 04 17A	100	5,2	<b>3,30</b>	-	100	■
IGPS045SS	PS 04 5SS	100	-	<b>3,30</b>	-	100	■

PS Ultra



spray sprinkler series Ultra  
with adjustable arc nozzle 0°/360°

Hunter®

Ref.	model	H	radius	€	pack	box	stock
IGPSU0210A	PSU 02 10A	50	3,0	<b>2,50</b>	-	100	■
IGPSU0212A	PSU 02 12A	50	3,7	<b>2,50</b>	-	100	■
IGPSU0215A	PSU 02 15A	50	4,6	<b>2,50</b>	-	100	■
IGPSU0217A	PSU 02 17A	50	5,2	<b>2,50</b>	-	100	■
IGPSU02LESS	PSU 02 LESS	50	-	<b>1,70</b>	-	100	■
IGPSU0410A	PSU 04 10A	100	3,0	<b>2,50</b>	-	100	■
IGPSU0412A	PSU 04 12A	100	3,7	<b>2,50</b>	-	100	■
IGPSU0415A	PSU 04 15A	100	4,6	<b>2,50</b>	-	100	■
IGPSU0417A	PSU 04 17A	100	5,2	<b>2,50</b>	-	100	■
IGPSU04LESS	PSU 04 LESS	100	-	<b>1,70</b>	-	100	■

SRS



spray sprinkler series SRS  
without nozzle

(until stocks last)

Hunter®

Ref.	model	H	€	pack	box	stock
IGSRS02	SRS-02	50	<b>2,00</b>	-	100	■
IGSRS03	SRS-03	75	<b>2,00</b>	-	100	■
IGSRS06	SRS-06	150	<b>7,25</b>	-	25	■
IGSRS12	SRS-12	300	<b>10,60</b>	-	25	■

INST



spray sprinkler series Institutional  
without nozzle

Hunter®

Ref.	model	H	€	pack	box	stock
IGINST04	INST-04	100	<b>5,50</b>	-	50	■

Pro-Spray



spray sprinkler series Pro-Spray  
without nozzle

Hunter®

Ref.	model	H	€	pack	box	stock
IGPROS00	PROS-00	adaptor	<b>0,78</b>	25	250	■
IGPROS02	PROS-02	50	<b>2,50</b>	-	50	■
IGPROS03	PROS-03	75	<b>2,50</b>	-	50	■
IGPROS04	PROS-04	100	<b>2,50</b>	-	50	■
IGPROS06	PROS-06	150	<b>8,30</b>	-	25	■
IGPROS12	PROS-12	300	<b>11,60</b>	-	25	■



UGELLI



adjustable arc nozzles  
0°/360°

**Hunter®**

Ref.	model	radius	€	pack	box	stock
IG17A	17A	5,2	1,26	25	250	<input type="checkbox"/>
IG15A	15A	4,6	1,26	25	250	<input type="checkbox"/>
IG12A	12A	3,7	1,26	25	250	<input type="checkbox"/>
IG10A	10A	3,0	1,26	25	250	<input type="checkbox"/>
IG8A	8A	2,4	1,26	25	250	<input type="checkbox"/>
IG6A	6A	-	1,26	25	250	<input type="checkbox"/>
IG4A	4A	-	1,26	25	250	<input type="checkbox"/>

UGELLI



adjustable arc nozzles 25°/360°  
separated jets

**Hunter®**

Ref.	model	radius	€	pack	box	stock
IGS8A	S-8A	2,1	1,26	25	250	<input type="checkbox"/>
IGS16A	S-16A	5,2	1,26	25	250	<input type="checkbox"/>

UGELLI



short radius nozzles

**Hunter®**

Ref.	model	radius	€	pack	box	stock
IG6H	6H	1,8	1,26	25	250	<input type="checkbox"/>
IG6Q	6Q	1,8	1,26	25	250	<input type="checkbox"/>
IG4H	4H	1,2	1,26	25	250	<input type="checkbox"/>
IG4Q	4Q	1,2	1,26	25	250	<input type="checkbox"/>
IG2H	2H	0,6	1,26	25	250	<input type="checkbox"/>
IG2Q	2Q	0,6	1,26	25	250	<input type="checkbox"/>

5CSTB



center stream bubbler nozzles

**Hunter®**

Ref.	model	radius	€	pack	box	stock
IG5CSTB	5-CST-B	1,2	1,26	25	250	<input type="checkbox"/>

PCN



pressure compensating bubbler nozzles

**Hunter®**

Ref.	model	radius	€	pack	box	stock
IGPCN25	PCN-25 (0,9 l/m)	0,3 ÷ 0,9	1,80	25	250	<input type="checkbox"/>
IGPCN50	PCN-50 (0,9 l/m)	0,3 ÷ 0,9	1,80	25	250	<input type="checkbox"/>
IGPCN10	PCN-10 (0,9 l/m)	0,3 ÷ 0,9	1,80	25	250	<input type="checkbox"/>
IGPCN20	PCN-20 (0,9 l/m)	0,3 ÷ 0,9	1,80	25	250	<input type="checkbox"/>

MS



pressure compensating micro spray nozzles

**Hunter®**

Ref.	model	radius	€	pack	box	stock
IGMSF	MS-F	1,5	3,15	25	250	<input type="checkbox"/>
IGMSH	MS-H	1,5	3,15	25	250	<input type="checkbox"/>
IGMSQ	MS-Q	1,5	3,15	25	250	<input type="checkbox"/>

UGELLI



fixed arc nozzles

**Hunter®**

Ref.	model	radius	€	pack	box	stock
IG17H	17H	5,2	1,26	25	250	<input type="checkbox"/>
IG17Q	17Q	5,2	1,26	25	250	<input type="checkbox"/>
IG15F	15F	4,6	1,26	25	250	<input type="checkbox"/>
IG15TQ	15TQ	4,6	1,26	25	250	<input type="checkbox"/>
IG15TT	15TT	4,6	1,26	25	250	<input type="checkbox"/>
IG15H	15H	4,6	1,26	25	250	<input type="checkbox"/>
IG15T	15T	4,6	1,26	25	250	<input type="checkbox"/>
IG15Q	15Q	4,6	1,26	25	250	<input type="checkbox"/>
IG12F	12F	3,7	1,26	25	250	<input type="checkbox"/>
IG12TQ	12TQ	3,7	1,26	25	250	<input type="checkbox"/>
IG12TT	12TT	3,7	1,26	25	250	<input type="checkbox"/>
IG12H	12H	3,7	1,26	25	250	<input type="checkbox"/>
IG12T	12T	3,7	1,26	25	250	<input type="checkbox"/>
IG12Q	12Q	3,7	1,26	25	250	<input type="checkbox"/>
IG10F	10F	3,0	1,26	25	250	<input type="checkbox"/>
IG10H	10H	3,0	1,26	25	250	<input type="checkbox"/>
IG10T	10T	3,0	1,26	25	250	<input type="checkbox"/>
IG10Q	10Q	3,0	1,26	25	250	<input type="checkbox"/>
IG8F	8F	2,4	1,26	25	250	<input type="checkbox"/>
IG8H	8H	2,4	1,26	25	250	<input type="checkbox"/>
IG8T	8T	2,4	1,26	25	250	<input type="checkbox"/>
IG8Q	8Q	2,4	1,26	25	250	<input type="checkbox"/>
IG5F	5F	1,5	1,26	25	250	<input type="checkbox"/>
IG5H	5H	1,5	1,26	25	250	<input type="checkbox"/>
IG5Q	5Q	1,5	1,26	25	250	<input type="checkbox"/>

UGELLI



corner strip nozzles

**Hunter®**

Ref.	model	radius	€	pack	box	stock
IGLCS515	LCS-515	1,8	1,26	25	250	<input type="checkbox"/>
IGRCS515	RCS-515	1,8	1,26	25	250	<input type="checkbox"/>
IGSS530	SS-530	1,2	1,26	25	250	<input type="checkbox"/>
IGES515	ES-515	1,2	1,26	25	250	<input type="checkbox"/>
IGCS530	CS-530	0,6	1,26	25	250	<input type="checkbox"/>
IGSS918	SS-918	0,6	1,26	25	250	<input type="checkbox"/>

MSBN



multi-stream bubbler nozzles

**Hunter®**

Ref.	model	radius	€	pack	box	stock
IGMSBN10F	MSBN-10F	0,30	1,88	25	250	<input type="checkbox"/>
IGMSBN20F	MSBN-20F	0,45	1,88	25	250	<input type="checkbox"/>
IGMSBN50H	MSBN-50H	0,30	1,88	25	250	<input type="checkbox"/>
IGMSBN10H	MSBN-10H	0,45	1,88	25	250	<input type="checkbox"/>
IGMSBN25Q	MSBN-25Q	0,30	1,88	25	250	<input type="checkbox"/>
IGMSBN50Q	MSBN-50Q	0,45	1,88	25	250	<input type="checkbox"/>

RZWS



Root Zone system

**Hunter®**

Ref.	model	€	pack	box	stock
IGRZWS1025	RZWS-1025 0,95 l/m (h 23,5 x 5,3 cm)	13,90	-	20	<input type="checkbox"/>
IGRZWS1850	RZWS-1850 1,90 l/m (h 46 x 8 cm)	26,90	-	12	<input type="checkbox"/>
IGRZWS3650	RZWS-3650 1,90 l/m (h 90 x 8 cm)	32,00	-	6	<input type="checkbox"/>

ELCi



electronic controller  
series ELC "Eco-logic" **outside** transformer

Hunter®

Ref.	model	zone	€	pack	box	stock
IGELC401IE	ELC-401i-E	4 (outside transformer)	<b>38,40</b>	1	8	■
IGELC601IE	ELC-601i-E	6 (outside transformer)	<b>43,10</b>	1	8	■

XCi



electronic controller  
series XC **outside** transformer

Hunter®

Ref.	model	zone	€	pack	box	stock
IGXC201IE	XC-201i-E	2 (outside transformer)	<b>51,00</b>	-	10	■
IGXC401IE	XC-401i-E	4 (outside transformer)	<b>58,80</b>	-	10	■
IGXC601IE	XC-601i-E	6 (outside transformer)	<b>66,70</b>	-	10	■
IGXC801IE	XC-801i-E	8 (outside transformer)	<b>86,30</b>	-	10	■

PRO Ci



electronic controller  
series PRO **outside** transformer

Hunter®

Ref.	model	zone	€	pack	box	stock
IGPC301IE	PC-301i-E	3-15 (outside transformer)	<b>117,60</b>	1	8	■
IGPCM300	Module	3	<b>39,20</b>	1	20	■
IGPCM900	Module	9	<b>152,90</b>	1	6	■

XC



electronic controller  
series XC **inside** transformer

Hunter®

Ref.	model	zone	€	pack	box	stock
IGXC401E	XC-401-E	4 (inside transformer)	<b>94,10</b>	-	10	■
IGXC601E	XC-601-E	6 (inside transformer)	<b>109,80</b>	-	10	■
IGXC801E	XC-801-E	8 (inside transformer)	<b>133,70</b>	-	10	■

PRO C



electronic controller  
series PRO C **inside** transformer

Hunter®

Ref.	model	zone	€	pack	box	stock
IGPC301E	PC-301-E	3-15 (inside transformer)	<b>141,10</b>	1	8	■
IGPCM300	Module	3	<b>39,20</b>	1	20	■
IGPCM900	Module	9	<b>152,80</b>	1	6	■

PCC



electronic controller  
series PCC **outside** transformer

Hunter®

Ref.	model	zone	€	pack	box	stock
IGPCC601E	PC-601-E	6	<b>156,80</b>	1	8	■
IGPCC901E	PC-901-E	9	<b>188,00</b>	1	8	■
IGPCC1201E	PC-1201-E	12	<b>219,50</b>	1	8	■
IGPCC1501E	PC-1501-E	15	<b>280,60</b>	1	8	■

ICC



electronic controller  
series ICC

Hunter®

Ref.	model	zone	€	pack	box	stock
IGICC801PL	ICC-801PL (plastic)	8 - 32	<b>325,30</b>	-	1	■
IGICC801M	ICC-801M (metal)	8 - 48	<b>646,80</b>	-	1	■
IGICM400	Module	4	<b>58,80</b>	-	1	■
IGICM800	Module	8	<b>118,00</b>	-	1	■

I-CORE



electronic controller  
series I-CORE

Hunter®

Ref.	model	zone	€	pack	box	stock
IGIC601PL	IC-601PL (plastic)	8 - 32	<b>313,00</b>	-	1	■
IGIC600M	IC-600M (metal)	8 - 48	<b>624,40</b>	-	1	■
IGICM600	Module	6	<b>77,60</b>	-	1	■

ACC



electronic controller  
series ACC

Hunter®

Ref.	model	zone	€	box	stock
IGACC1200	ACC-1200 (metal)	12 - 42	<b>980,00</b>	1	■
IGACC1200PP	ACC-1200PP (plastic)	12 - 42	<b>2.548,00</b>	1	■
IGACM600	ACM-600 module	6	<b>302,00</b>	1	■
IGAGM600	AGM-600 golf module	6	<b>333,10</b>	1	■
IGACCPED	ACC-PED pedestal	-	<b>391,20</b>	1	■

ACC



electronic controller  
series ACC Mono-wire

Hunter®

Ref.	model	zone	€	box	stock
IGACC99D	ACC-99D (metal)	99	<b>1.685,00</b>	1	■
IGACC99DPP	ACC-99DPP (plastic)	99	<b>3.370,00</b>	1	■
IGICD100	ICD-100 decoder	1	<b>92,50</b>	1	■
IGICD200	ICD-200 decoder	2	<b>162,30</b>	1	■
IGICD400	ICD-400 decoder	4	<b>187,40</b>	1	■
IGICD600	ICD-600 decoder	6	<b>325,30</b>	1	■
IGICDSEN	ICD-SEN decoder	sensor	<b>548,00</b>	1	■
IGID1ORG	ID1-ORG cable 2,08 mm	coil 760 m	*	1	■
IGIDWIRE1	ID2-WIRE1 cable 3,32 mm	coil 760 m	*	1	■

\* on request

SVC



battery operated controller  
series SVC



Ref.	model	zone	€	pack	box	stock
IGSVC100*	SVC-100	1	*	-	1	
IGSVC100VB	SVC-100VB	1 with 1" valve	<b>86,80</b>	-	10	
IGSVC200*	SVC-200	2	<b>123,70</b>	-	1	
IGSVC400*	SVC-400	4	<b>145,40</b>	-	1	

XCH



battery powered controller  
series XC HYBRID  
(battery-Ac)



Ref.	model	zone	€	pack	box	stock
IGXCH400	XCH-400	4	<b>124,60</b>	1	10	
IGXCH600	XCH-600	6	<b>140,30</b>	1	10	
IGXCH800	XCH-800	8	<b>156,00</b>	1	10	
IGXCH1000	XCH-1000	10	<b>176,40</b>	1	10	
IGXCH1200	XCH-1200	12	<b>195,10</b>	1	10	

WVC



battery operated controller  
series WVC



Ref.	model	zone	€	pack	box	stock
IGWVC100E*	WVC-100-E	1	<b>176,40</b>	-	1	
IGWVC200E*	WVC-200-E	2	<b>204,00</b>	-	1	
IGWVC400E*	WVC-400-E	4	<b>235,20</b>	-	1	
IGWVPE	WVP-E	console	<b>274,30</b>	-	1	

ICD-HP



decoder programmer for icd decoders  
ACC one cable

Ref.	model	€	pack	box	stock
IGICDHP	ICD-HP	<b>784,00</b>	1	1	

ICR-SRR



remote control system  
series ICR - SRR



Ref.	model	distance	€	pack	box	stock
IGICRKIT	ICR-KIT	700 m	<b>646,70</b>	-	1	
IGSRRKIT	SRR-KIT	50 m	<b>141,00</b>	-	1	

ROAM KIT



remote control system  
series ROAM KIT



Ref.	model	distance	€	pack	box	stock
IGROAMKIT	ROAM KIT	300 m	<b>195,10</b>	1	10	

IMMS



central control system series IMMS



Ref.	model	functions	€	pack	box	stock
IGIMMS2CD	IMMS-2CD	central control software for Windows 2000-XP	*	-	1	
IGIMMSCCE	IMMS-CCC-E	central computer communication unit	*	-	1	
IGIMMSSIHWE	IMMS-SI-HW-E	site interface unit hardwire	*	-	1	
IGIMMSSIMODE	IMMS-SI-MOD-E	site interface unit modem	*	-	1	
IGIMMSCIHWE	IMMS-CI-HW-E	controller interface unit hardwire	*	-	1	
IGIMMSCELGSME	IMMS-CEL-GSM-E	GSM cellular communication	*	-	1	
IGACCCOMHWR	ACC-COM-HWR	communications module for radio and/or hardwire with PC and ACC module	*	-	1	
IGACCHWIM	ACC-HWIM	hardwire interface module required for hardwire connections with ACC module	*	-	1	
IGACCCOMPOTS	ACC-COM-POTS	communications module for dial-up telephone modem with ACC module	*	-	1	
IGACCCOMGSME	ACC-COM-GSM-E	communications module for GSM cellular with ACC module	*	-	1	
IGAPPBRKT	APPBRKT	communications module bracket for plastic pedestal	*	-	1	
IGIMMSETCD	IMMS-ET-CD	ET software for IMMS 2	*	-	1	
IGFLOWCLICKIMMS	FLOW-CLICK-IMMS	flow sensor FLOWCLICK for IMMS (requires sensor body)	*	-	1	
IGGCBL	GCBL	shielded cable 1220 m coil	*	-	1	
IGGCBL100	GCBL-100	shielded cable 30 m coil	*	-	1	
IGGCBL300	GCBL-300	shielded cable 90 m coil	*	-	1	
IGGCBL500	GCBL-500	shielded cable 150 m coil	*	-	1	

\* on request

PGV



electric valve 24 VAC  
series PGV



Ref.	model	G	connections	flow control	€	box	stock
IGPGV100GB	PGV-100G-B	1"	F/F	no	15,90	20	■
IGPGV101GB	PGV-101G-B	1"	F/F	yes	16,30	20	■
IGPGV100MMB	PGV-100MM-B	1"	M/M	no	16,00	20	■
IGPGV101MMB	PGV-101MM-B	1"	M/M	yes	16,30	20	■
IGPGV151B	PGV-151-B	1" ½	F/F	yes	59,00	8	■
IGPGV201B	PGV-201-B	2"	F/F	yes	86,00	8	■

PGV



electric valve 9 VDC latch  
series PGV



Ref.	model	G	connections	flow control	€	box	stock
IGPGV100GBDC	PGV-100G-B-DC	1"	F/F	no	40,40	20	■
IGPGV101GBDC	PGV-101G-B-DC	1"	F/F	yes	42,00	20	■
IGPGV100MMBDC	PGV-100MM-B-DC	1"	M/M	no	42,00	20	■
IGPGV101MMBDC	PGV-101MM-B-DC	1"	M/M	yes	42,00	20	■
IGPGV151BDC	PGV-151-B-DC	½"	F/F	yes	80,00	8	■
IGPGV201BDC	PGV-201-B-DC	2"	F/F	yes	107,40	8	■

PGV JT



electric valve 24 VAC  
series PGV JT



Ref.	model	G	connections	flow control	€	box	stock
IGPGV100JT	PGV-100JT-B	1"	F/F	no	16,00	20	■
IGPGV101JT	PGV-101JT-B	1"	F/F	yes	16,30	20	■
IGPGV100JTM	PGV-100JT-MMB	1"	M/M	no	16,00	20	■
IGPGV101JTM	PGV-101JT-MMB	1"	M/M	yes	16,30	20	■

ICV



electric valve 24 VAC  
series ICV



Ref.	model	G	connections	flow control	€	box	stock
IGICV101GB	ICV-101G-B	1"	F/F	yes	77,60	12	■
IGICV151GB	ICV-151G-B	1" ½	F/F	yes	105,00	8	■
IGICV201GB	ICV-201G-B	2"	F/F	yes	146,60	8	■
IGICV301GB	ICV-301G-B	3"	F/F	yes	305,70	1	■

SENSORI



sensors



Ref.	model	functions	€	pack	box	stock
IGSOLARSYN	SOLARSYN	complete automatic sensor mod. SOLAR SYNC for PCC, Pro-C, I-Core and ICC	101,10	1	12	■
IGSOLARSYNSEN	SOLARSYN-SEN	complete automatic sensor mod. SOLAR SYNC SEN for X-Core and ACC	*	1	12	■
IGMINICLICK	MINI-CLICK	automatic rain sensor mod. MINICLICK	27,40	1	24	■
IGMINICLICKNO	MINI-CLICK-NO	automatic rain sensor normally open mod. MINICLICK	28,20	1	12	■
IGRAINCLICK	RAIN-CLICK	automatic rain sensor mod. RAINCLICK	25,90	1	24	■
IGRAINCLICKNO	RAIN-CLICK-NO	automatic rain sensor normally open mod. RAINCLICK	30,60	1	24	■
IGWRCINT	WRC-INT	wireless rain sensor with quick response system	77,60	1	12	■
IGWINDCLICK	WIND-CLICK	automatic wind sensor mod. WINDCLICK	116,80	1	1	■
IGFREEZECLICK	FREEZE-CLICK	automatic freeze sensor mod. FREEZECLICK	38,40	1	12	■
IGRFC	RFC	automatic freeze and rain	48,60	1	24	■
IGMWS	MWS	weather station combines wind and rain sensors	180,00	1	1	■
IGMWSFR	MWS-FR	weather station combines wind , rain and freeze sensors	211,70	1	1	■
IGETSYSTEM	ET-SYSTEM	automatic weather station	353,00	1	1	■
IGETWIND	ET-WIND	anemometer for use with the ET-System	353,00	1	1	■
IGBPSW	BPSW	bypass switch box for sensors	23,50	1	12	■
IGFLOWCLICK	FLOW-CLICK	flow sensor FLOWCLICK (requires sensor body)	247,00	1	1	■
IGHFS	HFS	Flow sensor for ACC and I-CORE (requires sensor body)	203,80	1	1	■
IGFCT100	FCT-100	PVC sensor body Pn10 D 1"	43,10	1	1	■
IGFCT150	FCT-150	PVC sensor body Pn10 D 1" ½	54,90	1	1	■
IGFCT200	FCT-200	PVC sensor body Pn10 D 2"	70,50	1	1	■
IGFCT300	FCT-300	PVC sensor body Pn10 D 3"	94,00	1	1	■
IGFCT400	FCT-400	PVC sensor body Pn10 D 4"	129,40	1	1	■

\* on request



Threaded swing joint  
serie SJ



Ref.	model	G x G x H	€	pack	box	stock
IGSJ506	SJ-506	½" x ½" x 150	1,77	-	150	<input type="checkbox"/>
IGSJ512	SJ-512	½" x ½" x 300	2,20	-	100	<input type="checkbox"/>
IGSJ706	SJ-706	¾" x ¾" x 150	1,92	-	150	<input type="checkbox"/>
IGSJ712	SJ-712	¾" x ¾" x 300	2,20	-	100	<input type="checkbox"/>
IGSJ7506	SJ-7506	¾" x ½" x 150	1,92	-	200	<input type="checkbox"/>
IGSJ7512	SJ-7512	¾" x ½" x 300	2,20	-	100	<input type="checkbox"/>



check valve  
serie Hcv



Ref.	model	G x G	€	pack	box	stock
IGHC50F50M	HC-50F-50M	½" f x ½" m	4,70	-	40	<input type="checkbox"/>
IGHC75F75M	HC-75F-75M	¾" f x ¾" m	5,65	-	40	<input type="checkbox"/>



accessories for static Pop-up



Ref.	model	description	€	pack	box	stock
IG461843	461843	check valve for PS	0,63	10	200	<input type="checkbox"/>
IG437400	437400	check valve for Pro-Spray	0,78	10	200	<input type="checkbox"/>
IG462810	462810	check valve for SRS	0,63	10	200	<input type="checkbox"/>
IGMPTOOL	MPTOOL	adjustment tool MP Rotator	0,82	10	200	<input type="checkbox"/>
IG172000	172000	adjustment tool Hunter	0,39	10	200	<input type="checkbox"/>

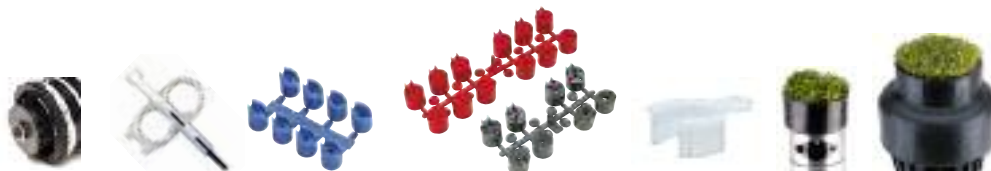

accessories for Hunter rotary Pop-up



Ref.	model	description	€	pack	box	stock
IG120300	120300	PGP screw set	0,39	10	-	<input type="checkbox"/>
IG463262	463262	SRM screw set	0,39	10	-	<input type="checkbox"/>
IG537900	537900	PGJ screw set	0,39	10	-	<input type="checkbox"/>
IG130900	130900	PGP standard nozzle set	0,39	10	-	<input type="checkbox"/>
IG327000	327000	SRM standard nozzle set	0,39	10	-	<input type="checkbox"/>
IG538700	538700	PGJ standard nozzle set	0,39	10	-	<input type="checkbox"/>
IG460010	460010	I25-I31 standard nozzle set	3,14	10	-	<input type="checkbox"/>
IG462458	462458	I40-I41 standard nozzle set	1,96	10	-	<input type="checkbox"/>
IG462078	462078	SRM and PGJ check valve	0,59	10	-	<input type="checkbox"/>
IG142300	142300	PGP check valve	0,78	10	-	<input type="checkbox"/>
IG233200	233200	PGP rack nozzle	0,39	10	-	<input type="checkbox"/>
IG665300	665300	PGP blue rack nozzle	0,20	10	-	<input type="checkbox"/>
IG466100	466100	"I20" short distance nozzle set	0,39	10	-	<input type="checkbox"/>
IG444800	444800	"I20" high flow nozzle set	1,57	10	-	<input type="checkbox"/>
IG782900	782900	"I20" "Blue Nozzle" rack	0,39	10	-	<input type="checkbox"/>
IG172000	172000	adjustment tool Hunter	0,39	10	-	<input type="checkbox"/>
IG123200	123200	collar insert nozzle	0,78	10	-	<input type="checkbox"/>
IG46000	46000	turf cup kit for I41 - I43	7,85	10	-	<input type="checkbox"/>
IG319100	319100	"I" handle tool for I90	1,10	10	-	<input type="checkbox"/>
IG467955	467955	turf cup kit for I90	54,80	10	-	<input type="checkbox"/>
IG473800	473800	rubber cover kit G990	90,10	1	-	<input type="checkbox"/>
IG473900	473900	rubber cover kit G995	90,10	1	-	<input type="checkbox"/>



accessories for electric valve



Ref.	model	description	€	pack	box	stock
IG434100	434100	solenoid 24 VAC for PGV - PGV JT - ICV	9,00	10	-	<input type="checkbox"/>
IG458200	458200	solenoid 9 VDC latch for PGV - PGV JT - ICV	23,50	10	-	<input type="checkbox"/>
IGACCUSET	ACCU-SET	pressure regulator ACCU-SET for PGV - PGV JT - ICV	58,80	10	-	<input type="checkbox"/>
IGACCUSYNCAJ	ACCU-SYNC-ADJ	pressure regulator ACCU-SYNC for PGV - PGV JT - ICV	*	10	-	<input type="checkbox"/>
IG332100	332100	spare diaphragm for PGV100	9,40	1	1	<input type="checkbox"/>

\* on request

G 75S



electric valve 24 VAC



Ref.	G	connections	flow control	€	box	stock
IBG75S301N1	3/8"	threaded F/F	no	15,00	50	<input type="checkbox"/>
IBG75S401N1	1/2"	threaded F/F	no	15,00	50	<input type="checkbox"/>
IBG75S50161	3/4"	threaded F/F	no	15,50	20	<input type="checkbox"/>
IBG75S50151	3/4"	threaded F/F	yes	15,70	20	<input type="checkbox"/>
IBG75S60161	1"	threaded F/F	no	15,50	20	<input type="checkbox"/>
IBG75S60151	1"	threaded F/F	yes	15,70	20	<input type="checkbox"/>
IBG75S70151	1" 1/2	threaded F/F	yes	50,30	6	<input type="checkbox"/>
IBG75S80151	2"	threaded F/F	yes	57,40	6	<input type="checkbox"/>

G 75S



electric valve 9 VDC latch



Ref.	G	connections	flow control	€	box	stock
IBG75S60152	1"	threaded F/F	yes	24,60	20	<input type="checkbox"/>
IBG75S70152	1" 1/2	threaded F/F	yes	58,40	6	<input type="checkbox"/>
IBG75S80152	2"	threaded F/F	yes	65,00	6	<input type="checkbox"/>

G 75C



electronic controller with batteries 2 station with valve



Ref.	G	model	€	pack	box	stock
IBG75C26060	1"	2 valve	97,90	1	9	<input type="checkbox"/>

G 75C



electronic controller with batteries one station with valve



Ref.	G	connections	flow control	€	box	stock
IBG75C100	without valve	-	-	54,00	30	<input type="checkbox"/>
IBG75C150	3/4"	threaded F/F	no	61,30	10	<input type="checkbox"/>
IBG75C160	1"	threaded F/F	no	61,30	10	<input type="checkbox"/>
IBG75C170	1" 1/2	threaded F/F	yes	94,70	6	<input type="checkbox"/>
IBG75C180	2"	threaded F/F	yes	100,10	6	<input type="checkbox"/>

G 75C



electronic controller multistation



Ref.	model	zone	€	pack	box	stock
IBG75C81	DC latch	8	123,90	1	6	<input type="checkbox"/>
IBG75C82	AC	8	137,50	1	6	<input type="checkbox"/>

G 75C



electronic controller with batteries one station with valve mod. Window



Ref.	G	model	€	pack	box	stock
IBG75C260	1"	Window	55,60	1	10	<input type="checkbox"/>

G 75A



3 way pilot 1/8"



Ref.	model	D	type	€	pack	box	stock
IBG75A110321	plastic	1,2	NC - 24 VAC	20,30	1	25	<input type="checkbox"/>
IBG75A110322	plastic	1,2	NC - 9-12 VDC latch	25,10	1	25	<input type="checkbox"/>
IBG75A110421	plastic	1,2	NA - 24 VAC	20,30	1	25	<input type="checkbox"/>
IBG75A110422	plastic	1,2	NA - 9-12 VDC latch	25,10	1	25	<input type="checkbox"/>
IBG75A110431	plastic	1,6	NC - 24 VAC	20,30	1	25	<input type="checkbox"/>
IBG75A310321	metal	1,2	NC - 24 VAC	35,60	1	25	<input type="checkbox"/>
IBG75A310322	metal	1,2	NC - 9-12 VDC latch	35,90	1	25	<input type="checkbox"/>
IBG75A310412	metal	1,0	NC - 9-12 VDC latch	35,90	1	25	<input type="checkbox"/>

G 75PR



pressure relief valve



Ref.	G	connections	flow control	€	box	stock
IBG75PR7015	1" 1/2	threaded F/F	yes	145,90	2	<input type="checkbox"/>
IBG75PR8015	2"	threaded F/F	yes	159,50	3	<input type="checkbox"/>

G 75P



pilot GALIT 1/8"



Ref.	model	power supply	€	pack	box	stock
IBG75P101	plastic	24 VAC	92,00	1	-	<input type="checkbox"/>
IBG75P102	plastic	9-12 VDC latch	92,00	1	-	<input type="checkbox"/>
IBG75P104	plastic	12 VDC	92,00	1	-	<input type="checkbox"/>

G 750



spare solenoid for electric valve BACCARA



Ref.	-	description	€	pack	stock
IBG7501001	-	24 VAC	11,90	1	<input type="checkbox"/>
IBG7501002	-	9-12 VDC latch	17,50	1	<input type="checkbox"/>
IBG7501004	-	12 VDC	14,30	1	<input type="checkbox"/>
IBG7501005	-	24 VDC	14,30	1	<input type="checkbox"/>

MEM



spare diaphragm for electric valve BACCARA



Ref.	-	model	€	pack	stock
IBG75SMEM60	-	G 75S 3/4" / 1"	5,90	1	<input type="checkbox"/>
IBG75SMEM80	-	G 75S 1" 1/2 / 2"	12,60	1	<input type="checkbox"/>

P PLUS



pop-up  
series PROPLUS

Ref.	model	H	radius	€	pack	box	stock
IGPTV0000NSPR	SUPER PRO	100	6,7 ÷ 15,3	15,70	-	20	<input checked="" type="checkbox"/>

M PRO



pop-up  
series MINI PRO

Ref.	model	H	radius	€	pack	box	stock
IGPTV0000NMNP	MINI PRO	100	5,0 ÷ 9,0	13,00	-	25	<input checked="" type="checkbox"/>

PRC



electronic controller series PRC  
outside transformer

Ref.	model	zone	€	pack	box	stock
IGPRC00000T02	94122	2 (outside transformer)	42,80	-	10	<input checked="" type="checkbox"/>
IGPRC00000T04	94124	4 (outside transformer)	45,20	-	10	<input checked="" type="checkbox"/>
IGPRC00000T06	94126	6 (outside transformer)	48,80	-	10	<input checked="" type="checkbox"/>

PRE



hybrid controller series PRE  
outside transformer

Ref.	model	zone	€	pack	box	stock
IGPRE00000T04	94004	2 (outside transformer)	81,00	-	3	<input checked="" type="checkbox"/>
IGPRE00000T06	94006	4 (outside transformer)	104,00	-	3	<input checked="" type="checkbox"/>
IGPRE00000T08	94008	9 (outside transformer)	134,00	-	3	<input checked="" type="checkbox"/>

PRT



hybrid controller series PRT  
inside transformer

Ref.	model	zone	€	pack	box	stock
IGPRT00000T04	94024	4 (inside transformer)	104,00	1	3	<input checked="" type="checkbox"/>
IGPRT00000T06	94026	6 (inside transformer)	136,00	1	3	<input checked="" type="checkbox"/>
IGPRT00000T08	94028	9 (inside transformer)	163,00	1	3	<input checked="" type="checkbox"/>
IGPRT00000T12	94022	12 (inside transformer)	204,00	1	3	<input checked="" type="checkbox"/>

GT1



electronic controller with batteries one  
station Green Timer with valve



Ref.	model	G	€	pack	box	stock
IGGT1250	GT1	¾"	40,00	1	6	<input checked="" type="checkbox"/>

ASM



metal impact sprinkler



Ref.	G	radius	bar	l/h	€	pack	box	stock
IIASM12	½"	12	3,5	950	9,15	10	50	<input checked="" type="checkbox"/>

ASP



plastic impact sprinkler



Ref.	G	radius	bar	l/h	€	pack	box	stock
IIASP12	½"	12	3,5	950	1,89	50	200	<input checked="" type="checkbox"/>



HP series pop-up with adjustable arc nozzle 20°/360°

(until stocks last)



Ref.	model	H	€	pack	box	stock
IHHP02-08A	8A	50	2,46	-	100	■
IHHP02-10A	10A	50	2,46	-	100	■
IHHP02-12A	12A	50	2,46	-	100	■
IHHP02-15A	15A	50	2,46	-	100	■
IHHP02-17A	17A	50	2,46	-	100	■
IHHP04-08A	8A	100	2,56	-	100	■
IHHP04-10A	10A	100	2,56	-	100	■
IHHP04-12A	12A	100	2,56	-	100	■
IHHP04-15A	15A	100	2,56	-	100	■
IHHP04-17A	17A	100	2,56	-	100	■



adjustable arc nozzle 20°/360°

(until stocks last)



Ref.	model	€	pack	box	type
IHAA17	17A	1,14	25	500	■
IHAA15	15A	1,14	25	500	■
IHAA12	12A	1,14	25	500	■
IHAA10	10A	1,14	25	500	■
IHAA8	8A	1,14	25	500	■
IHAA6	6A	1,14	25	500	■
IHAA4	4A	1,14	25	500	■



700 series body pop-up

(until stocks last)



Ref. male connections <sup>1</sup>	Ref. female connections <sup>2</sup>	H	€	pack	box	stock
IH702	IH702F	50	1,65	-	100	■
IH703	IH703F	75	1,69	-	100	■
IH704	IH704F	100	1,76	-	100	■
IH706	IH706F	150	4,53	-	100	■
IH712	IH712F	300	9,30	-	50	-



fixed arc spray nozzles

(until stocks last)



Ref. male connections <sup>2</sup>	Ref. female connections <sup>1</sup>	H	€	pack	box	stock
IH501M-110S	IH501-110S	15Q	0,91	25	500	■
IH501M-111S	IH501-111S	15T	0,91	25	500	■
IH501M-112S	IH501-112S	15H	0,91	25	500	■
IH501M-113S	IH501-113S	15TT	0,91	25	500	■
IH501M-114S	IH501-114S	15TQ	0,91	25	500	■
IH501M-115S	IH501-115S	15F	0,91	25	500	■
IH501M-116S	IH501-116S	12Q	0,91	25	500	■
IH501M-117S	IH501-117S	12T	0,91	25	500	■
IH501M-118S	IH501-118S	12H	0,91	25	500	■
IH501M-119S	IH501-119S	12TT	0,91	25	500	■
IH501M-120S	IH501-120S	12TQ	0,91	25	500	■
IH501M-121S	IH501-121S	12F	0,91	25	500	■
IH501M-122S	IH501-122S	10QLA	0,91	25	500	■
IH501M-141S	IH501-141S	10TLA	0,91	25	500	■
IH501M-123S	IH501-123S	10HLA	0,91	25	500	■
IH501M-124S	IH501-124S	10FLA	0,91	25	500	■
IH501M-125S	IH501-125S	8FSQ	0,91	25	500	■
IH501M-142S	IH501-142S	8FST	0,91	25	500	■
IH501M-126S	IH501-126S	8FSH	0,91	25	500	■
IH501M-127S	IH501-127S	8FSF	0,91	25	500	■
IH501M-128S	IH501-128S	8FSQ-LG	0,91	25	500	■
IH501M-129S	IH501-129S	8FSH-LG	0,91	25	500	■
IH501M-130S	IH501-130S	6FSF-LG	0,91	25	500	■
IH501M-131S	IH501-131S	15SST4	0,91	25	500	■
IH501M-132S	IH501-132S	17SST9	0,91	25	500	■
IH501M-133S	IH501-133S	15EST	0,91	25	500	■
IH501M-134S	IH501-134S	15CST	0,91	25	500	■
IH501M-135S	IH501-135S	10SSQ	0,91	25	500	■
IH501M-136S	IH501-136S	10SSH	0,91	25	500	■
IH501M-137S	IH501-137S	10SSF	0,91	25	500	■
IH501M-138S	IH501-138S	35SSQ	0,91	25	500	■
IH501M-139S	IH501-139S	35SSH	0,91	25	500	■
IH501M-140S	IH501-140S	35SSF	0,91	25	500	■



900 series body pop-up

(until stocks last)



Ref. male connections <sup>1</sup>	Ref. female connections <sup>2</sup>	H	€	pack	box	stock
IH902	IH902F	50	2,20	-	100	■
IH903	IH903F	75	2,31	-	75	■
IH904	IH904F	100	2,31	-	75	■
IH905	IH905F	125	3,98	-	50	■
IH906	IH906F	150	4,55	-	50	■
IH906S	IH906SF	150	4,98	-	50	■
IH912	IH912F	300	9,30	-	50	■



900 T series telescopic pop-up body

(until stocks last)



Ref.	model	H	€	pack	box	stock
IH907	907T	170	6,12	-	100	■
IH913	913T	320	8,87	-	75	■

<sup>1</sup> Compatible with: Hit - Rain Bird - L.R.Nelson - Irritrol

<sup>2</sup> Compatible with: Toro



HDC



HDC series residential controller

(until stocks last)



Ref.	model	zone	€	pack	box	stock
IHHDC4-I	DIAL 4	4	<b>48,90</b>	1	6	<input type="checkbox"/>
IHHDC6-I	DIAL 6	6	<b>64,40</b>	1	6	<input type="checkbox"/>

RAIN PRO



RAIN PRO series controller

(until stocks last)



Ref.	model	zone	€	pack	box	stock
IHRP1800M-I	RAIN PRO (inside transformer)	3 - 12	<b>80,40</b>	1	8	<input type="checkbox"/>
IHRP18N00M-I	RAIN PRO (inside transformer)	3 - 15	<b>85,40</b>	1	8	<input type="checkbox"/>
IHRP800M-I	RAIN PRO (outside transformer)	3 - 12	<b>99,50</b>	1	8	<input type="checkbox"/>
IHRP8N00M-I	RAIN PRO (outside transformer)	3 - 15	<b>106,40</b>	1	8	<input type="checkbox"/>
IHRP800M3-I	Module	3	<b>25,20</b>	1	20	<input type="checkbox"/>
IHRP800M4-I	Module	4	<b>29,20</b>	1	20	<input type="checkbox"/>

LOGIC P



LOGIC PLUS series controller 2 wire

(until stocks last)



Ref.	model	zone	€	pack	box	stock
IHLC2	LOGIC PLUS 2	42	<b>1.221,00</b>	1	1	<input type="checkbox"/>
IHLC3	LOGIC PLUS 3	128	<b>1.788,00</b>	1	1	<input type="checkbox"/>



accessories for LOGIC PLUS series controllers

(until stocks last)



Ref.	model	description	€	pack	box	stock
IHRP	RP	Decoder	<b>78,30</b>	1	16	<input type="checkbox"/>
IHSPDF	SPDF	Surge protection device	<b>47,20</b>	1	16	<input type="checkbox"/>

100



100 Series Pvc electric valve

(until stocks last)



Ref.	model	G	connections	flow control	€	box	stock
IH110606BBLK	100	¾"	F/F	no	<b>12,90</b>	12	<input type="checkbox"/>
IH110656BBLK	100	¾"	F/F	yes	<b>14,00</b>	12	<input type="checkbox"/>
IH110707BBLK	100	¾"	M/M	no	<b>12,90</b>	12	<input type="checkbox"/>
IH110757BBLK	100	¾"	M/M	yes	<b>14,00</b>	12	<input type="checkbox"/>
IH110000BBLK	100	1"	F/F	no	<b>12,90</b>	12	<input type="checkbox"/>
IH110050BBLK	100	1"	F/F	yes	<b>14,00</b>	12	<input type="checkbox"/>
IH110101BBLK	100	1"	M/M	no	<b>12,90</b>	12	<input type="checkbox"/>
IH110151BBLK	100	1"	M/M	yes	<b>14,00</b>	12	<input type="checkbox"/>

200



200 Series Pvc electric valve

(until stocks last)



Ref.	model	G	connections	flow control	€	box	stock
IH27500B	200	¾"	F/F	no	<b>14,70</b>	12	<input type="checkbox"/>
IH27505B	200	¾"	F/F	yes	<b>16,70</b>	12	<input type="checkbox"/>
IH21000B	200	1"	F/F	no	<b>14,70</b>	12	<input type="checkbox"/>
IH21005B	200	1"	F/F	yes	<b>16,70</b>	12	<input type="checkbox"/>
IH21505B	200	1" ½	F/F	yes	<b>49,90</b>	8	<input type="checkbox"/>
IH22005B	200	2"	F/F	yes	<b>62,40</b>	8	<input type="checkbox"/>

8400



8400 Series Pvc electric valve

(until stocks last)



Ref.	model	G	connections	flow control	€	box	stock
IH8475TB	8400	¾"	F/F	no	<b>14,80</b>	20	<input type="checkbox"/>
IH8410B	8400	1"	F/F	no	<b>14,80</b>	20	<input type="checkbox"/>



replacement parts for HIT valves

(until stocks last)



Ref.	model	description	€	pack	box	stock
IH504051	504051	24 vac solenoid for series 200	<b>7,20</b>	-	10	<input type="checkbox"/>
IH504057	504057	24 vac solenoid for series 8400	<b>7,20</b>	-	10	<input type="checkbox"/>
IH210D	210D	diaphragm for series 200 - 1"	<b>4,00</b>	-	10	<input type="checkbox"/>
IH215D	215D	diaphragm for series 200 - 1" ½	<b>11,10</b>	-	10	<input type="checkbox"/>
IH220D	220D	diaphragm for series 200 - 2"	<b>13,70</b>	-	10	<input type="checkbox"/>
IH8400D	8400D	diaphragm for series 8400	<b>4,00</b>	-	10	<input type="checkbox"/>

nipple with or

407



Ref.	G x G	material	€	pack	box	type	stock
IG40760M0N320	1" x 1"	POM	0,54	50	300	C	<input type="checkbox"/>
IG40720M0N320	1" x 1"	PP	0,35	50	300	C	<input type="checkbox"/>
IG40720M0N500	1" ½ x 1" ½	PP	1,60	10	240	B	<input type="checkbox"/>
IG40720M0N630	2" x 2"	PP	2,50	10	160	B	<input type="checkbox"/>

reducing nipple with or

419



Ref.	G x G	material	€	pack	box	type	stock
IG41960M0N32C	1" x 1"	POM	0,52	50	300	C	<input type="checkbox"/>
IG41920M0N32C	1" x 1"	PP	0,34	50	300	C	<input type="checkbox"/>
IG41920M0N50E	1" ½ x 1" ½	PP	1,50	10	300	B	<input type="checkbox"/>
IG41920M0N63F	2" x 2"	PP	2,40	10	200	B	<input type="checkbox"/>

coupling with or/  
compression fitting

425



Ref.	G x G	material	€	pack	box	type	stock
IG42520D0N32C	1" x 25	PP	1,08	10	160	B	<input type="checkbox"/>
IG42520D0N32D	1" x 32	PP	1,25	10	160	B	<input type="checkbox"/>

elbow with or/  
compression fitting

428



Ref.	G x G	material	€	pack	box	type	stock
IG42820D0N32C	1" x 25	PP	1,40	10	200	B	<input type="checkbox"/>
IG42820D0N32D	1" x 32	PP	1,55	10	140	B	<input type="checkbox"/>

coupling f/f with or

420



Ref.	G x G	material	€	pack	box	type	stock
IG42020F0N320	1" x 1"	PP	1,40	50	150	C	<input type="checkbox"/>

coupling m/f with or

424



Ref.	G x G	material	€	pack	box	type	stock
IG42460D0N320	1" x 1"	POM	0,92	50	250	C	<input type="checkbox"/>
IG42420D0N320	1" x 1"	PP	0,60	50	250	C	<input type="checkbox"/>
IG42420D0V500	1" ½ x 1" ½	PP	2,10	5	170	B	<input type="checkbox"/>
IG42420D0V630	2" x 2"	PP	3,15	5	120	B	<input type="checkbox"/>

elbow f/f with or

426



Ref.	G x G	material	€	pack	box	type	stock
IG42660F0N320	1" x 1"	POM	1,50	50	150	C	<input type="checkbox"/>
IG42620F0N320	1" x 1"	PP	0,93	50	150	C	<input type="checkbox"/>
IG42620F0V500	1" ½ x 1" ½	PP	3,40	5	95	B	<input type="checkbox"/>
IG42620F0V630	2" x 2"	PP	4,85	5	50	B	<input type="checkbox"/>

elbow m/f with or

427



Ref.	G x G	material	€	pack	box	type	stock
IG42760D0N320	1" x 1"	POM	1,20	50	150	C	<input type="checkbox"/>
IG42720D0N320	1" x 1"	PP	0,76	50	150	C	<input type="checkbox"/>
IG42720D0V500	1" ½ x 1" ½	PP	2,65	5	90	B	<input type="checkbox"/>
IG42720D0V630	2" x 2"	PP	4,05	5	70	B	<input type="checkbox"/>

tee m/m/f with or

432



Ref.	G x G x G	material	€	pack	box	type	stock
IG43260D0N320	1" x 1" x 1"	POM	1,25	50	100	B	<input type="checkbox"/>
IG43220D0N320	1" x 1" x 1"	PP	0,76	50	100	B	<input type="checkbox"/>
IG43220D0V500	1" ½ x 1" ½ x 1" ½	PP	2,90	5	70	C	<input type="checkbox"/>
IG43220D0V630	2" x 2" x 2"	PP	4,30	5	50	C	<input type="checkbox"/>

tee m/f/f with or

431



Ref.	G x G	material	€	pack	box	type	stock
IG43160D0N320	1" x 1" x 1"	POM	1,66	50	100	C	<input type="checkbox"/>
IG43120D0N320	1" x 1" x 1"	PP	0,97	50	100	C	<input type="checkbox"/>
IG43120D0V500	1" ½ x 1" ½ x 1" ½	PP	3,75	5	60	B	<input type="checkbox"/>
IG43120D0V630	2" x 2" x 2"	PP	5,10	5	40	B	<input type="checkbox"/>

cross f/f/f/m with or

433



Ref.	G x G x G x G	material	€	pack	box	type	stock
IG43360D0N320	1" x 1" x 1" x 1"	POM	2,80	50	100	C	<input type="checkbox"/>
IG43320D0N320	1" x 1" x 1" x 1"	PP	1,76	50	100	C	<input type="checkbox"/>
IG43320D0V500	1" ½ x 1" ½ x 1" ½ x 1" ½	PP	4,00	5	25	B	<input type="checkbox"/>
IG43320D0V630	2" x 2" x 2" x 2"	PP	7,20	5	15	B	<input type="checkbox"/>

Residential irrigation | Manifold

Group  
4701

434



2 way manifold



Ref.	G x G x G	€	pack	box	type	stock
IG43460D0N320	1" x 1" x 1"	10,80	5	75	B	<input checked="" type="checkbox"/>

435



3 way manifold



Ref.	G x G x G x G	€	pack	box	type	stock
IG43560D0N320	1" x 1" x 1" x 1"	15,30	5	35	B	<input checked="" type="checkbox"/>

436



4 way manifold



Ref.	G x G x G x G x G	€	pack	box	type	stock
IG43660D0N320	1" x 1" x 1" x 1" x 1"	19,80	5	35	B	<input checked="" type="checkbox"/>

Residential irrigation | Valve boxes

Group  
4701

PCZ



valve box with bolt and edge



Ref.	model	shape	€	pack	pallet	stock
IGPOZ2000N01C	MINI	circular	2,31	1	468	<input checked="" type="checkbox"/>
IGPCZ2000N02C	LARGE	circular	4,20	1	126	<input checked="" type="checkbox"/>
IGPCZ2000N04R	STANDARD	rectangular	13,20	1	138	<input checked="" type="checkbox"/>
IGPCZ2000N06R	JUMBO	rectangular	25,70	1	92	<input checked="" type="checkbox"/>

POZ



valve box with bolt



Ref.	model	shape	€	pack	pallet	stock
IGPOZ2000N02C	LARGE	circular	4,20	1	126	<input checked="" type="checkbox"/>
IGPOZ2000N04R	STANDARD	rectangular	13,20	1	150	<input checked="" type="checkbox"/>
IGPOZ2000N06R	JUMBO	rectangular	25,70	1	100	<input checked="" type="checkbox"/>

EST



valve box extension



Ref.	model	H	€	pack	pallet	stock
IGEST2000N14R	STANDARD	90	10,80	1	270	<input type="checkbox"/>
IGEST2000N04R	STANDARD	165	13,00	1	130	<input type="checkbox"/>
IGEST2000N06R	JUMBO	165	18,00	1	78	<input type="checkbox"/>

PVZ



fiber glass valve box

Ref.	model	shape	€	pack	pallet	stock
IGPVZ2000V01C	MINI	circular	*	1	468	<input type="checkbox"/>
IGPVZ2000V02C	LARGE	circular	*	1	126	<input type="checkbox"/>
IGPVZ2000V04R	STANDARD	rectangular	*	1	138	<input type="checkbox"/>
IGPVZ2000V06R	JUMBO	rectangular	*	1	92	<input type="checkbox"/>
IGPVZ2000V08R	SUPERJUMBO	rectangular	*	1	-	<input type="checkbox"/>
IGPVZ2000V12R	MAXI	rectangular	*	1	-	<input type="checkbox"/>

PVM



valve box with metal valve



Ref.	G	shape	€	pack	pallet	stock
IGPVM2S00V0CC	¾"	circular	18,50	30	510	<input checked="" type="checkbox"/>

valve boxes dimensions

model	Ref. PCZ - POZ			Ref. PVZ		
	lower base	upper base	H	lower base	upper base	H
MINI	200	160	230	212	165	228
LARGE	320	225	250	330	247	266
STANDARD	380 x 496	273 x 405	300	406 x 533	298 x 341	304
JUMBO	500 x 640	370 x 520	300	482 x 684	377 x 542	304
SUPERJUMBO	-	-	-	590 x 831	406 x 647	381
MAXI	-	-	-	457 x 1035	495 x 825	457

\* on request

GFP



barbed elbow  
for antitorion pipe



Ref.	D x G	€	pack	box	type	stock
IGGFP6000N20B	16 x 1/2"	0,19	100	1000	C	<input type="checkbox"/>
IGGFP6000N20C	16 x 3/4"	0,19	100	800	C	<input type="checkbox"/>

RFP



barbed male adaptor  
for antitorion pipe



Ref.	D x G	€	pack	box	type	stock
IGRFP60M0N20B	16 x 1/2"	0,19	100	1000	C	<input type="checkbox"/>
IGRFP60M0N20C	16 x 3/4"	0,19	100	900	C	<input type="checkbox"/>

MFP



barbed coupling  
for antitorion pipe



Ref.	D x D	€	pack	box	type	stock
IGMFP6000N200	16 x 16	0,18	100	1800	C	<input type="checkbox"/>

GPP



elbow for antitorion pipe



Ref.	D x G	€	pack	box	type	stock
IGGPP30M0A20B	16 x 1/2"	0,49	50	600	B	<input type="checkbox"/>
IGGPP30M0A20C	16 x 3/4"	0,49	50	600	B	<input type="checkbox"/>
IGGPP30M0N25B	20 x 1/2"	0,49	50	600	B	<input type="checkbox"/>
IGGPP30M0N25C	20 x 3/4"	0,49	50	600	B	<input type="checkbox"/>

TPP



antitorion pipe for pop-up



Ref.	D	€	pack	box	type	stock
FTD00B00J	16	0,89	coil 30 mt	1	-	<input type="checkbox"/>
FTD00C00J	20	1,06	coil 30 mt	1	-	<input type="checkbox"/>

PRR



adjustable extension



Ref.	G x G x G	€	pack	box	type	stock
IGPRR20M0N20C	3/4" x 3/4" x 1/2"	1,40	25	200	-	<input type="checkbox"/>

PRS



cut-off riser



Ref.	G x G x H	€	pack	box	type	stock
IGPRS70M0N200	1/2" x 1/2" x 150	0,26	25	400	B	<input type="checkbox"/>
IGPRS70M0N20C	1/2" x 3/4" x 150	0,26	25	350	B	<input type="checkbox"/>
IGPRS70M0N250	3/4" x 3/4" x 150	0,29	25	300	B	<input type="checkbox"/>
IGPRS70M0N25D	3/4" x 1" x 150	0,31	25	250	B	<input type="checkbox"/>

BGI



BLU-LOCK elbow

Ref.	G x G	€	pack	box	stock
IGBGI200	1/2" x 1/2"	<b>1,15</b>	25	300	<input type="checkbox"/>

BGM



BLU-LOCK elbow male thread

Ref.	G x G	€	pack	box	stock
IGBGM20B	1/2" x 1/2"	<b>0,69</b>	25	300	<input type="checkbox"/>
IGBGM20C	1/2" x 3/4"	<b>0,74</b>	25	300	<input type="checkbox"/>

BMA



BLU-LOCK coupling

Ref.	G x G	€	pack	box	stock
IGBMA200	1/2" x 1/2"	<b>1,08</b>	25	300	<input type="checkbox"/>

BTE



BLU-LOCK tee

Ref.	G x G x G	€	pack	box	stock
IGBTE200	1/2" x 1/2" x 1/2"	<b>1,64</b>	25	300	<input type="checkbox"/>

BAN



flag signalling

Ref.	colour	€	pack	box	stock
IGBAN00000VER	green	<b>0,40</b>	25	350	<input type="checkbox"/>
IGBAN00000BIA	white	<b>0,40</b>	25	350	<input type="checkbox"/>
IGBAN00000BLU	blue	<b>0,40</b>	25	350	<input type="checkbox"/>

BS



self drilling bracket

Ref.	D x G	€	pack	box	stock
IGBS2550	25 x 1/2"	<b>2,05</b>	25	300	<input type="checkbox"/>
IGBS3350	32 x 1/2"	<b>2,05</b>	25	300	<input type="checkbox"/>
IGBS3375	32 x 3/4"	<b>2,05</b>	25	300	<input type="checkbox"/>
IGBS4050	40 x 1/2"	<b>2,40</b>	25	300	<input type="checkbox"/>
IGBS4075	40 x 3/4"	<b>2,40</b>	25	300	<input type="checkbox"/>

BGF



BLU-LOCK elbow female thread

Ref.	G x G	€	pack	box	stock
IGBGF20B	1/2" x 1/2"	<b>0,82</b>	25	300	<input type="checkbox"/>
IGBGF20C	1/2" x 3/4"	<b>0,85</b>	25	300	<input type="checkbox"/>

BGS



BLU-LOCK swivel elbow male threaded

Ref.	G x G	€	pack	box	stock
IGBGSF20B	1/2" x 1/2"	<b>1,26</b>	25	300	<input type="checkbox"/>
IGBGSF20C	1/2" x 3/4"	<b>1,26</b>	25	300	<input type="checkbox"/>

BRM



BLU-LOCK straight connector male thread

Ref.	G x G	€	pack	box	stock
IGBRM20B	1/2" x 1/2"	<b>0,72</b>	25	300	<input type="checkbox"/>
IGBRM20C	1/2" x 3/4"	<b>0,74</b>	25	300	<input type="checkbox"/>

BTU



BLU-LOCK pipe 33 mt coil

Ref.	G	€	pack	box	stock
IGBTU200	1/2"	<b>29,10</b>	1	33	<input type="checkbox"/>

BV



waterproof connector

Ref.	-	€	pack	box	stock
IGBVS1	-	<b>0,85</b>	50	300	<input type="checkbox"/>
IGBVS2	-	<b>1,60</b>	50	300	<input type="checkbox"/>

GS3



3 joint swivel elbows

Ref.	G x H	€	pack	box	stock
IGGS310M0ND30	1" x 300	<b>19,00</b>	1	300	<input type="checkbox"/>
IGGS310M0NF30	1" 1/2 x 300	<b>30,80</b>	1	300	<input type="checkbox"/>





	page
Tools	104
Tapes and glues	105



hole puncher



Ref.	D	€	pack	box	type	stock
IIFUS2000N025	2.5	3,90	10	170	B	■
IIFUS2000N030	3.0	3,90	10	170	B	■
IIFUS2000N036	3.6	3,90	10	170	B	■
IIFUS2000N040	4.0	3,90	10	170	B	■
IIFUS2000N050	5.0	3,90	10	170	B	■
IIFUS2000N060	6.0	3,90	10	170	B	■
IIFUS2000N070	7.0	3,90	10	170	B	■
IIFUS2000N080	8.0	3,90	10	170	B	■
IIFUS2000N090	9.0	3,90	10	170	B	■
IIFUS2000N100	10	3,90	10	170	B	■
IIFUS2000N110	11	3,90	10	170	B	■
IIFUS2000N120	12	3,90	10	170	B	■
IIFUS2000N130	13	3,90	10	170	B	■
IIFUS2000N140	14	3,90	10	170	B	■

FUS replacement tip



Ref.	D	€	pack	box	type	stock
OIPUN00000025	2.5	1,50	10	-	-	■
OIPUN00000030	3	1,50	10	-	-	■
OIPUN00000036	3.6	1,50	10	-	-	■
OIPUN00000040	4	1,50	10	-	-	■
OIPUN00000050	5	1,50	10	-	-	■
OIPUN00000060	6	1,50	10	-	-	■
OIPUN00000070	7	1,50	10	-	-	■
OIPUN00000080	8	1,50	10	-	-	■
OIPUN00000090	9	1,50	10	-	-	■
OIPUN00000100	10	1,50	10	-	-	■
OIPUN00000110	11	1,50	10	-	-	■
OIPUN00000120	12	1,50	10	-	-	■
OIPUN00000130	13	1,50	10	-	-	■
OIPUN00000140	14	1,50	10	-	-	■

3 pin hole puncher



Ref.	D	€	pack	box	type	stock
IIFUT2000N060	6	5,00	10	170	B	■
IIFUT2000N070	7	5,00	10	170	B	■
IIFUT2000N080	8	5,00	10	170	B	■
IIFUT2000N090	9	5,00	10	170	B	■
IIFUT2000N100	10	5,00	10	170	B	■
IIFUT2000N110	11	5,00	10	170	B	■
IIFUT2000N120	12	5,00	10	170	B	■
IIFUT2000N130	13	5,00	10	170	B	■
IIFUT2000N140	14	5,00	10	170	B	■

FUT replacement tip



Ref.	D	€	pack	box	type	stock
OIPUT00300060	6	2,80	10	-	-	■
OIPUT00300070	7	2,80	10	-	-	■
OIPUT00300080	8	2,80	10	-	-	■
OIPUT00300090	9	2,80	10	-	-	■
OIPUT00300100	10	2,80	10	-	-	■
OIPUT00300110	11	2,80	10	-	-	■
OIPUT00300120	12	2,80	10	-	-	■
OIPUT00300130	13	2,80	10	-	-	■
OIPUT00300140	14	2,80	10	-	-	■

hole puncher (3 mm hole)



Ref.	D	€	pack	box	type	stock
IIPFU00000320	16 - 20	11,50	1	-	-	■
IIPFU00000332	25 - 32	15,50	1	-	-	■

layflat cutter



Ref.	D	€	pack	box	type	stock
IIFOR00000140	14	55,00	1	-	-	■
IIFOR00000200	20	92,00	1	-	-	■

plier for insertion of minicouplings in micropipes



Ref.	D	€	pack	box	type	stock
IIINS00000050	5/6	19,00	1	-	-	■
IIINS00000070	7/8	19,00	1	-	-	■

pipe cutter



Ref.	D	€	pack	box	type	stock
IIPNT00000250	16-25	9,00	1	20	-	■
IIPNT00000320	16-32	13,00	1	20	-	■

clamping wrench



Ref.	D	€	pack	box	type	stock
IICSE20000R300	25 - 63	11,60	1	-	-	■
IICSE20000R750	25 - 110	11,60	1	-	-	■
IICSE20000R999	filters	12,30	-	-	-	■

cutter for offtakes



Ref.	D	€	pack	box	type	stock
IIPNZ00000000	12 mm	57,00	1	-	-	■
IIPNZ00000180	18 mm	57,00	1	-	-	■
IIPNZ00000PUN	puncher/pin 12 mm	6,50	1	-	-	■
IIPNZ00000P18	puncher/pin 18 mm	6,50	1	-	-	■
IIPNZ00000INS	inserting	6,50	1	-	-	■



NAS



teflon

Ref.	-	€	pack	box	type	stock
IINAS00000120	½" x 12 x 0,076	<b>0,31</b>	10	250	-	<input type="checkbox"/>

NSP



professional teflon

Ref.	-	€	pack	box	type	stock
IINSP00000150	19 x 15 x 0,2	<b>2,20</b>	63	630	-	<input type="checkbox"/>

COL



PVC glue  
WELD-ON®

Ref.	package	€	pack	box	type	stock
IICOL13628	125 ml.	<b>4,40</b>	1	24	-	<input type="checkbox"/>
IICOL13606	500 ml.	<b>13,10</b>	1	12	-	<input type="checkbox"/>
IICOL13607	1.000 ml.	<b>21,20</b>	1	12	-	<input type="checkbox"/>
IICOL10201	cleaner	<b>10,50</b>	1	12	-	<input type="checkbox"/>

TAN



TANGIT

Ref.	package	€	pack	box	type	stock
IITAN00000125	125 gr	<b>7,60</b>	1	12	-	<input type="checkbox"/>
IITAN00000250	250 gr	<b>12,20</b>	1	12	-	<input type="checkbox"/>
IITAN00000500	500 gr	<b>21,00</b>	1	12	-	<input type="checkbox"/>
IITAN00000999	1000 gr	<b>36,70</b>	1	12	-	<input type="checkbox"/>
IITAN00000SOL	cleaner	<b>23,70</b>	1	12	-	<input type="checkbox"/>

Note

A large area of the page is filled with horizontal dashed lines, providing a space for handwritten notes.

Note

A large area of horizontal dashed lines for taking notes.

Note

A large area of the page is filled with horizontal dashed lines, providing a space for handwritten notes.

Packaging

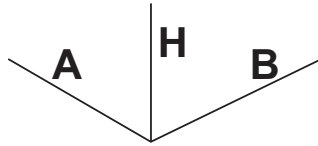

model	A mm	B mm	H mm	Vol. m <sup>3</sup>
B	385	585	283	0,064
C	385	280	280	0,030
U	387	587	284	0,065
T	387	797	284	0,088
J	385	585	435	0,098
W	800	1200	730	0,701
V	800	1200	900	0,864

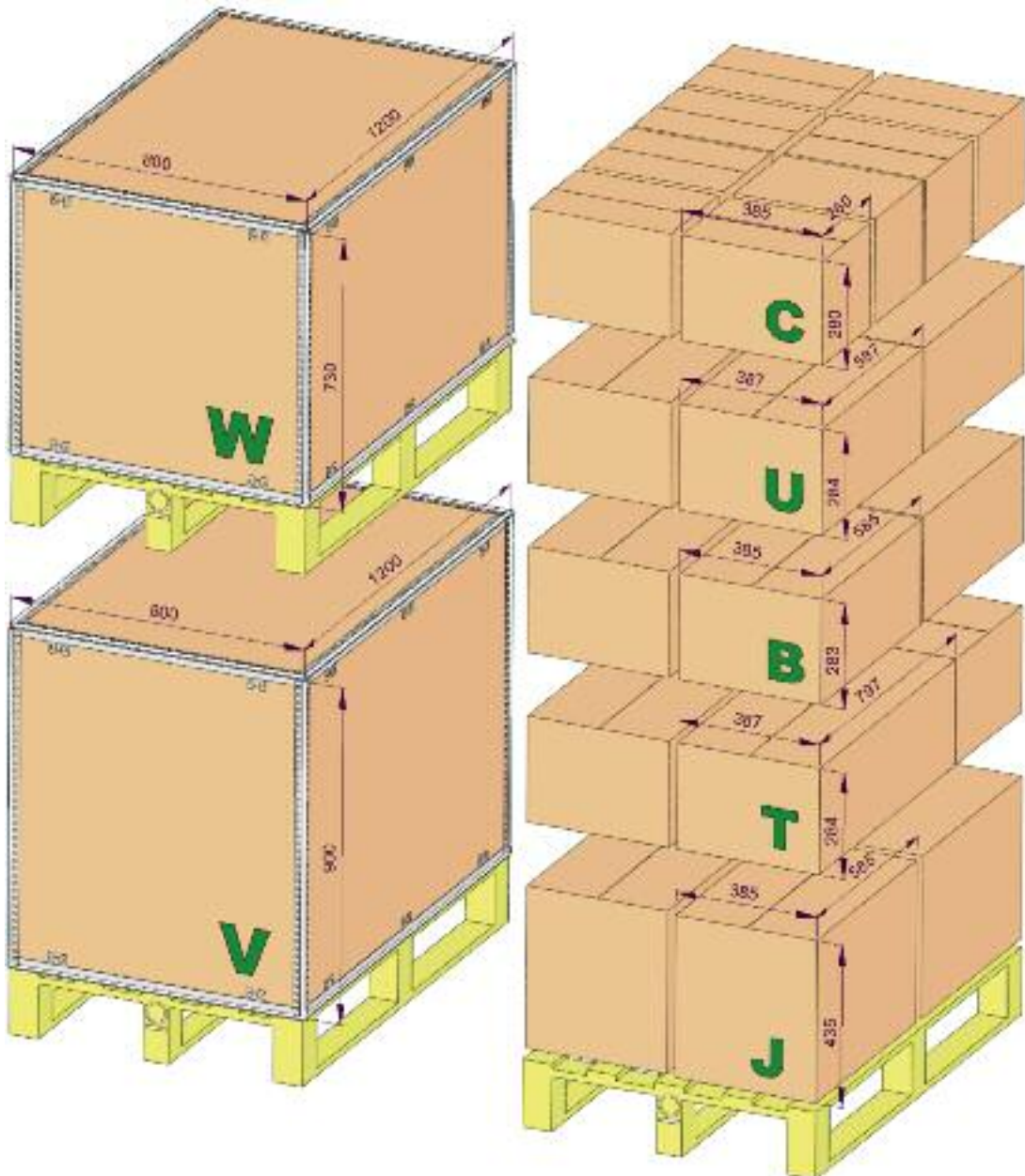

Discount

Product	Item	Page	Group	Discount
<b>Drip irrigation Microirrigation</b>	iDROP drippers - iDROP drippers accessories - Various drippers - Stakes - Microfittings - Hooks and accessories	6 - 11	4401	%
	Irritec static sprinklers	12	4501	%
	Agridor sprinklers - Agridor accessories	13 - 16	6103	%
	Sprinklers medium and long radius	17	6901	%
<b>Filtering</b>	Manual plastic filters	20 - 25	4301	%
	Automatic plastic filters	26 - 27	4302	%
	Coated metal filters - Filter accessories	28 - 32	5101	%
<b>Fertigation Automation</b>	Venturi Injectors - Fertilizer injectors	34	5002	%
	Dosmatic proportional injectors	35	6104	%
	Hydraulic/electric pumps - Agitators - Fertigation accessories	37 - 38	6901	%
	Controllers	39	4801	%
	Baccara - Electric valves and controllers	40	6102	%
	Hydraulic valves - Water meters - Hydraulic valves accessories	41 - 42	6901	%
<b>Fittings Valves low pressure</b>	Quick joints pn4 for PE pipe - Insert fittings for PE pipe - Offtakes	44 - 48	4001	%
	Layflat fittings	49	4005	%
	Tape fittings - Dripline fittings - Compact cylinder valves - Rabbit cylinder valves - Ball valves - Mini ball valves	50 - 58	4002	%
	Quick coupling valves - Pressure regulators - Air release valves	59	4201	%
	Threaded fittings	60 - 61	4003	%
	Fittings for spiral pipes	62	4001	%
	<b>Accessories</b>	Tools	104	4601
Tapes and glues		105	6901	%

%

<b>Fittings Valves high pressure</b>	Compression fittings Connecto Plus	64 - 67	4902	%
	Compression fittings Connecto	68 - 71	4901	%
	Clamp saddles with reinforcing ring	72 - 73	4102	%
	Clamp saddle	74	4101	%
	PVC fittings	76 - 82	6903	%
	PVC valves	83	6902	%

%

<b>Residential irrigation</b>	Hunter rotary Pop-up - Hunter spray Pop-up - Controllers - Electric valves - Sensors - Accessories	86 - 93	6101	%
	Baccara electric valves and controllers	94	6102	%
	Various gardening	95	6901	%
	Hit   Pop-up - Controllers - Electric valves	96 - 97	6105	%
	Manifold - Valve boxes - Accessories	98 - 100	4701	%
	Gardening accessories	101	6901	%

%

## Terms of sale

• **Validity**

These general terms of sale cancel and replace all previous ones. Applies to all shipments made by Irritec® S.r.l. to the BUYER from the date of issue of this catalogue/price list. They apply to all future business, even if not specifically referred to them. Any additional or different provisions concerning the general conditions of purchase order as well as those covered by any verbal agreements are considered valid only if confirmed in writing by Irritec® S.r.l.

• **Products and codes**

Products reflect the features indicated in the catalogues. The products identification must refer to the codes and their nomenclature.

• **Technical documentation**

Technical documents such as drawings, descriptions, figures, as well as any information on the properties, characteristics, size or weight, is intended to be purely informational and non-binding. Irritec® S.r.l. reserves the right to make changes deemed necessary in the light of technical progress and in any case not in the sense of a loss of performance and features shown

• **Confirmation of an order**

The orders received through our sales network or directly sent by the BUYER are final only when accepted by our regular order confirmation, that in the absence of immediate feedback are confirmed in their entirety.

• **Fiscal data**

The BUYER must communicate the fiscal data as well as the precise CORPORATE NAME. Irritec® S.r.l. is not responsible for mistakes in BUYER's data.

• **Prices and delivery**

Irritec® S.r.l. applies prices in force at the order date, unless the customer requests deferred deliveries. In this case will be applied prices in force at the time of shipment. Unless otherwise agreed, are net, ex stock Irritec® S.r.l., including standard packaging. All additional costs (transport, insurance, import costs, transit, export certification, taxes, duties and customs fees) are paid by the BUYER.

• **Fix duties**

Orders with net amount of less than € 500,00 (Excluding incidental expenses, transportation and taxes) are burdened with a fixed fee of € 20,00.

• **Payment**

Payments can't be deferred. In case of late payments Irritec® S.r.l. will apply interest rates according to current bank rates. In case of foreign supplies, payments will be through irrevocable letter of credit or agreed conditions.

• **Packing**

For logistical reasons and to speed up delivery times, Irritec® S.r.l. reserves the right to bring the quantities ordered in multiples of standard packages. In addition, non-standard packages required are charged at cost.

• **Official regulations at Purchaser site**

The BUYER is obliged to inform Irritec® S.r.l. about official regulations or any other instructions existing in the destination place, concerning the execution of the supply and compliance with safety regulations and/or homologation.

• **Forwarding and risk transfer**

If not specifically required by the BUYER, Irritec® S.r.l. will consider the best way of delivery.

Goods will be delivered at BUYER'S risk even for carriage paid shipments. Insurance is only on request and at BUYER's expenses.

• **Delivery terms**

Unless otherwise agreed, delivery times are not binding, but merely indicative and approximate. The delivery period begins to run after the definition of the order. In any case, the period of delivery shall be extended due to:

- 1) failure and / or unexpected events to equipments
- 2) unavailability of raw materials and / or semi-finished products required
- 3) any other unforeseeable event

Irritec® S.r.l. can dispatch the order in more than one shipment, except for BUYER's specified request.

• **Balance**

Any balances will be sent as soon as available, unless otherwise specified by the BUYER.

• **Ownership**

The delivered goods remain property of Irritec® S.r.l. until receipt of payment of all invoices relating to the supply contract. If contract agreements will be not respected, Irritec® S.r.l. is authorized to request the return of the goods.

• **Technical assistance off-site**

The technical staff is at the BUYER's disposal to provide any kind of information and support on products in the catalog.

• **Guarantee**

Our products are of good quality and meet the standards listed in the catalogs. The warranty is limited to repair and / or replacement of our products due to failure due to defective manufacture or material due to Irritec® S.r.l.

The warranty is void if:

- 1) 2 years have elapsed from the delivery of the material
- 2) the material has been used outside the specified operating conditions
- 3) the material has been altered or manipulated

The warranty is limited to the replacement of defective products or repairing them with the complete exclusion of any other responsibility, particularly with the exclusion of compensation or recognition of the damage caused by the use of our products.

• **Claims**

The BUYER has the obligation to control the delivered goods. Claims must be communicated through registered letter or fax within the law. Even in case of a valid claim the BUYER shall pay the amount at maturity of the invoice.

• **Authorization for return**

Goods can not be returned unless they are specifically authorized by our officers. The product returned for non-technical problems, is accepted only if it is in excellent conditions (both the product and the packaging, which must be original), otherwise the additional costs will be debited.

• **Law and Jurisdiction**

The commercial relationship between Irritec® S.r.l. and the BUYER shall be governed by the Italian law. For any dispute between the parties, jurisdiction is the Court of Patti (Me).

• **IIP**

In case of branded products, the ISTITUTO ITALIANO DEI PLASTICI officials have to be allowed by the BUYER to examine and verify their conformity with standards.





*don't wait for rain*

**Irritec s.r.l.**

Via Santa Lucia  
98071 Capo d'Orlando (ME) - Italy  
TEL +39 0941 922111 - Fax +39 0941 958554  
www.irritec.com - irritec@irritec.com



Sistema di Irrigazione per la  
Qualità  
UNI EN ISO 9001:2008

**Certificato N° 435**  
Progettazione e produzione di accoppi ed accessori in materie plastiche per irrigazione, impianto e giardinaggio. Commercializzazione di accessori.



Sistema di Irrigazione  
Automatico  
UNI EN ISO 14001:04

**Certificato N° 100**  
Progettazione e produzione di accoppi ed accessori in materie plastiche per irrigazione, impianto e giardinaggio attraverso i processi di stampaggio ad iniezione, trafilazione e produzione di stampi. Commercializzazione di accessori.  
SAB.1 - Via Isaurica, sng. Via Galles - 98071 Capo d'Orlando (ME)  
SAB.2 - Via Fiumi 5 - 98071 Capo d'Orlando (ME)  
SAB.3 - Via Fiumi 7 - 98071 Capo d'Orlando (ME)

**Bologna warehouse**

Via Caduti di Sabbionno, 5  
40011 Anzola dell'Emilia (BO) - Italy  
TEL +39 051 6508020 - Fax +39 051 6508149

© Any reproduction, publication, further distribution or public exhibition of materials provided in this Price list in whole or in part, is strictly prohibited



DEI LU00E1101